

DYNAMIC CONDUCTANCE TUBE & TRANSISTOR TESTER

MODEL

666



**EICO**

INSTRUCTION

MANUAL

666-1

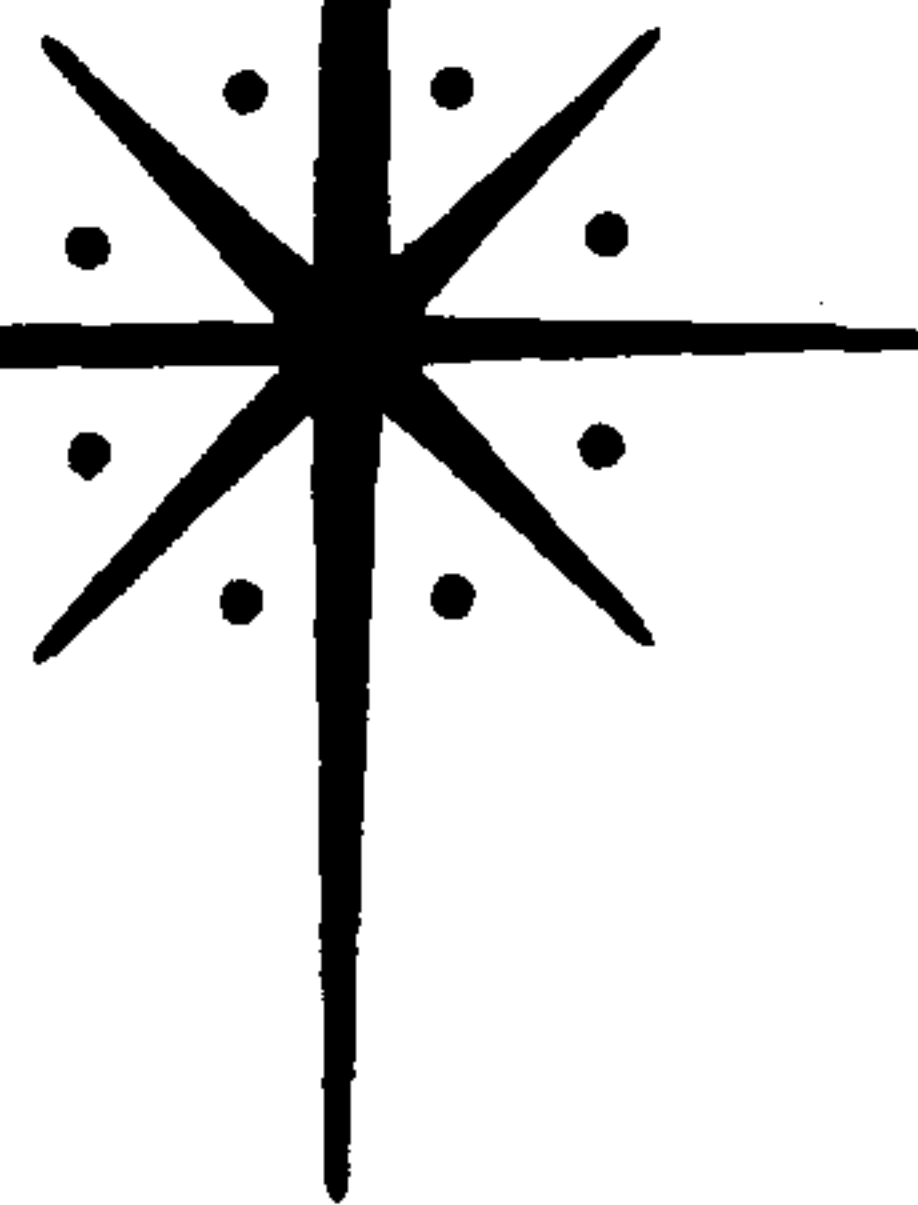

ELECTRONIC INSTRUMENT CO. INC.  
3300 NORTHERN BLVD., L. I. CITY 1, N. Y.



## GENERAL DESCRIPTION

The EICO Model 666 Dynamic Conductance Tube & Transistor Tester is one of the first thoroughly practical service instruments able to test both tubes and transistors. Among its advantages are rapid and simple operation, close simulation of actual tube operating conditions, and unexcelled thoroughness and accuracy of test. The outstanding mechanical design and layout, coupled with components carefully selected for ruggedness, makes the Model 666 extremely well-suited for the hard usage of daily service work.

All components of the Model 666 tube tester are assembled to the heavy-gauge aluminum front panel, which is in turn top-mounted by 14 screws to flanges on all four sides of the steel case. A detachable steel cover is mounted to the back of the case with separable hinges so that the cover may easily be removed for use of the instrument as a counter-top model or replaced to convert it back to a portable instrument.

There are ten different tube sockets on the panel to accommodate any receiving tube, old or new, and whether it be standard size, miniature, or sub-miniature. In addition, pilot and Christmas tree lamps can be checked rapidly using the center of the large 7-pin socket. A special transistor socket accommodates both n-p-n and p-n-p transistors. To protect against damage due to current overload, a type 3AG 1 ampere fuse is connected in series with the primary of the power transformer.

## SPECIFICATIONS

LINE VOLTAGE & FREQUENCY: 105-130v, 60 cycles.

Note: Do not connect to a dc line.

POWER CONSUMPTION: 10 watts with no tube/transistor under test; 50 watts at maximum load.

TUBE TYPES TESTED: Nearly all 4, 5, 6, and 7 pin, octal, loctal, miniature 7 and 9 pin, sub-miniature 5, 6, and 7 pin (in line base) and 8 pin (circular base) receiving tubes, many small transmitting and special-purpose tubes, voltage regulators, cold cathode rectifiers, electron-ray indicators, and ballast tubes. Tests color and monochrome tv picture tubes with accessory adaptor.

TUBE TESTS: a) Direct-reading of inter-element and cathode heater leakage in ohms on a 0 to 20 meg-ohms scale. DC test voltage always applied in correct polarity to eliminate emission effects from readings. b) Merit test, which is an emission reading for diodes and rectifiers and a dynamic conductance (combined

plate conductance, mutual conductance, and emission) reading for triodes, tetrodes, and pentodes.

TRANSISTORS TESTED: Nearly all n-p-n and p-n-p types.

TRANSISTOR TESTS: a) Leakage measurement of collector current with emitter grounded and no base signal. b) Direct reading of current amplification factor or Beta (change in collector current caused by change in base current).

ACCURACY OF LINE VOLTAGE INDICATION:  $\pm 3\%$

SIZE: 12" X 15" X 6".

WEIGHT: 20 lbs.

## FUNCTIONS OF CONTROLS

A necessary supplement to the operating instructions is the following description of control functions. Several controls, for example, have unusual secondary functions which must be understood in making settings.

FILAMENT SELECTOR — The dial of this control indicates rms a-c volts tapped from the power transformer and applied to the tube filament at each position. Do not take the setting for granted; check the roll chart and set it to the value shown for the particular tube type. The last position, marked "Z", is used when checking cold cathode tubes such as the 0Z4 for which the plate voltage of the Model 666 is insufficient to initiate conduction in the tube. The 117 volts available from the FILAMENT switch is thrown in series with the plate voltage of 180 volts at the "Z" position to provide a total voltage sufficient to initiate tube conduction. A 3K resistor, placed in series with this circuit, provides current limiting to protect the tube after the start of conduction.

LINE ADJ. — This control is a continuously variable potentiometer connected across a portion of the primary winding. It permits adjustment of transformer secondary voltages to the standard test values despite line voltage and filament load variations. The LINE push-button serves to insert a standard resistance in the leakage test circuit which will result in exactly half-scale deflection (LINE mark) when the LINE ADJ. control has been set properly in relation to the actual line voltage and filament load. The actual line voltage may be read off the dial of the LINE ADJ. control with an accuracy of  $\pm 3\%$  when line adjustment is made under no-load conditions (no tube inserted for testing).

GRID control — A continuously variable potentiometer which taps the desired grid voltage up to a maximum of 5, 15, or 45 volts, depending on the setting of the V lever. A snap switch, which takes up the first few divisions on the dial, is actuated in the most counter-clockwise position and inserts a 400 $\Omega$  current-limiting resistor in series



with the plate supply (for high-current rectifiers). At settings of 7 and above, the resistor is shorted.

**PLATE control** — A continuously variable rheostat in series with the meter which acts as a "fine" adjustment of meter sensitivity in conjunction with the "coarse" adjustment provided by the "S" lever switch.

**LEVER switches 1 through 9 & C** — These are single section six-position switches which connect the similarly numbered tube socket terminals (lever C is for the cap lead) to the proper voltage sources for the tube which is to be tested. At the 1 position, each switch contacts ground; at the 2 position, each switch contacts the filament voltage; at the 3 position, each switch contacts the screen voltage; at the 4 position, each switch contacts plate voltage; in the 5 position, each switch contacts grid voltage; in the 6 position, each switch furnishes an open circuit.

**LEVER V** — This is a three section switch with four positions (1 through 4). 5, 15, 45, 90, and 180 volt taps on a separate secondary winding on the transformer are so connected to these switch sections as to provide selection from four combinations of plate, screen, and grid voltages. The plate and screen voltages selected are applied through the MERIT switch to the corresponding position contacts on lever switches 1 through C. The grid voltage selected is applied to the GRID potentiometer so that the desired portion of the total available voltage can be accurately tapped off by means of the dial calibration and applied to the grid position contacts on lever switches 1 through C, also through the MERIT switch. The plate screen, and grid voltages selected at each position of the V switch are as follows:

<u>Pos'n</u>	<u>Plate</u>	<u>Screen</u>	<u>Grid</u>
1	45 v	15 v	0-5 v
2	90	45	0-15
3	180	90	0-15
4	180	90	0-45

**LEVER S** — This is a single section six-position switch which selects the value of shunt resistance placed across the meter and PLATE control potentiometer. As such, lever S is a "coarse" meter sensitivity control which is used in conjunction with the "fine" control provided by the PLATE potentiometer. Position 1 provides the least meter sensitivity for high current tubes and position 5 the highest sensitivity for low current tubes; intermediate positions provide a variety of sensitivities necessary for testing the many tube types encountered. At position 6 of the S switch, the grid voltage from the V switch is connected through the 24,000 ohm current-limiting resistor in testing light-duty diodes.

**PUSH-SWITCHES 1 through 9 & C** — Each of these switches serves as a transfer switch for the tube element connected to the corresponding base pin number. The #1 switch controls all connections to the #1 socket terminals; the #2 switch controls all connections to the #2 socket terminals; and so forth, in order, through to the #9 switch for the #9 terminal of the noval socket.

The C switch controls the connections to the cap lead. These push switches serve the following functions:

With the MERIT and LINE switches at their normal position, depressing one of these switches transfers the corresponding tube element to one side of the ohmmeter circuit (with the remaining tube elements all grounded together with the other side of the ohmmeter circuit) as required for the inter-element leakage tests. These push-switches are also primarily responsible for two of the outstanding features of this tube tester; one feature being that in the majority of cases all sections of multi-section tubes draw their normal current when any one section is tested; the second being the rapid testing afforded multi-section tubes due to the saving in set-up time. These advantages are obtained because the push switches permit selection of the tube base pin which will be connected to the transformer power supply through the meter circuit when the MERIT switch is pulled down, in order that the current through the corresponding tube element (normally the plate of a tube or a tube section) be measured for MERIT testing. The remaining tube base pins (connected to the push switches which are not depressed for the particular MERIT test) are connected either directly to the transformer power supply or indirectly through a potentiometer.

**RESET push button** — This button is a convenience intended to permit restoring of a depressed push-switch to the normal position.

**H-K LEAKage push switch** — This is a momentary switch which is used for heater-cathode leakage testing. When the push switch for an indirectly heated cathode (underlined in the LEAK column of the roll chart) is depressed to transfer the cathode to one side of the ohmmeter circuit, the H-K LEAK button is depressed also to break the ground connection of the remaining "lumped" elements in order that cathode emission current to these elements will be excluded from the cathode heater leakage measurement.

**TRANSISTOR TEST selector** — This is a special five-position multi-circuit switch performing the following functions: a) At the TUBE position the transistor test socket is de-energized and the meter connected so as to render it available for line adjustment, leakage testing, and merit testing; b) At the transistor test positions, it applies a dc bias voltage between the collector and emitter socket terminals, of polarity depending on whether the n-p-n or p-n-p positions are used.

At the 1 position for either transistor type, the meter is inserted in the collector circuit in series with a 1K current-limiting resistor to measure the current ( $I_{CEO}$ ) under these conditions. At either 2 position, a 200K resistor is connected between the collector side of the power supply and the base to put a small current into the base. The current gain, Beta, is then read on the meter, which remains in the collector circuit.

**WARNING:** Be certain as to the type of transistor (n-p-n or p-n-p) you are testing. Testing a transistor using the positions designated for the opposite type may damage the tester meter or the transistor. Note that shorted transistors may cause the meter to read past full scale at the



"N-P-N 1" or P-N-P 1" position. Should this occur, turn the switch back to the "TUBE" position immediately and discard the defective transistor, after you have first checked to see that the correct test position was used for the particular type.

**SPECIAL SOCKET CONNECTIONS**— Several socket terminal connections are not standard and should be noted. The pilot light socket in the center of the 7-pin socket is connected across the selected filament voltage (shell to ground, center post to filament switch arm). The center of the loktal socket is connected to ground. The sub-miniature in-line socket has no numbers assigned to its seven terminals. In the Model 666, these terminals are connected to the push-switches as if they were numbered 1 to 7 beginning at the index dot on the panel. However, a consistent connection procedure has been established (the roll chart settings are given accordingly), which is as follows: With tube base and socket indexes matched (dot or spur on tube base to dot at right of socket on the panel), the tube leads are inserted in order so as not to skip any socket terminals starting from the extreme right.

## OPERATING INSTRUCTIONS

### PRELIMINARY STEPS FOR TUBE OR TRANSISTOR TESTING.

1. Insert the power plug in a 105-125 volts AC, 50/60 cps line outlet. Do not use a DC line outlet or any AC line outlet other than specified above.
2. Turn the tester on by rotating the LINE ADJ. control clock-wise from AC-OFF.
3. Set the TRANSISTOR TEST selector to TUBE, regardless of whether it is a tube or transistor that is to be tested.
4. Make a preliminary line adjust by holding down the LINE button while turning the LINE ADJ. control until the meter pointer is over the LINE ADJ. mark on the meter (center scale). Release the LINE button at the conclusion of the adjustment.

### TUBE TESTING CONTINUED

5. Press the RESET button to release any button which may be down from a previous setting. Make sure the TRANSISTOR TEST selector is set at "TUBE".
6. Move all 12 lever switches down to the "1" position.
7. Rotate one or both roll chart wheels until the tube type you wish to test appears in one of the windows. Obsolete types will be found in a supplement to this manual.
8. Note the number of lines of settings devoted to the tube on the chart. Each line of settings corresponds to a section of the tube (1 line for a single diode, triode, or pentode; 2 lines for a double diode or triode or pentagrid converter; 3 lines for a duodiode-triode, etc.) Each section of the tube is tested by making the settings indicated on a single line of the chart and then depressing the MERIT lever. All inter-element short and leakage testing must be performed before any of the MERIT tests is performed as

a safeguard to the tube tester. The push-buttons which must be pressed down to complete the leakage and short testing are all given in the first line of settings. Specific instructions for making settings and performing the required tests follow.

9. The first 3 settings following the tube type are for the FIL. selector, GRID control and PLATE control, in that order. Set these controls accordingly.

10. The next 12 settings are for lever switches 1,2,3,4, 5,6,7,8,9,C,V, and S in that order. Set these levers accordingly.

11. Check all settings to make sure that no mistake has been made.

12. Insert the tube into the socket which matches its base. (The socket just above the TRANSISTOR TEST selector is for transistors only. All other sockets are for tubes only). If the rectangular sub-miniature socket is used, turn the tube so that its index (red dot, black dot, glass spur) matches the dot on the panel; then insert each lead into a socket terminal in order, not skipping any socket terminals starting from the right. If there is a top cap on the tube, connect to it with the cap clip lead.

13. Allow sufficient warm-up time before proceeding. For battery-operated tubes and h.v. rectifiers (1B3 type) warm up is almost instantaneous; for most receiving tubes 10 to 20 seconds; for high power pentodes, triodes, and rectifiers 20-40 seconds. Note that the MERIT test (step 17) should not be performed until the stated warm-up time has elapsed.

14. Press the LINE button and note the meter reading. Depending on the filament drain of the tube under test, the meter will read more or less to the left of the LINE ADJ. mark (center scale). Holding the LINE button down turn the LINE ADJ. control until the meter pointer is again over the LINE ADJ. mark. Release the LINE button at the conclusion of this adjustment.

15. Refer to the first (or only) line of settings for the tube and note the buttons listed in the LEAK. column. Press down each of the buttons listed one at a time (in order), observing the meter each time. (See next paragraph for evaluation of leakage readings.) The underlined leakage buttons are for indirectly heated cathodes; when these buttons are depressed, the resulting meter reading will be valid only when the H-K LEAK button is also depressed. Failure to do so will not normally cause damage to the tube, but will give too low a leakage reading due to emission to other elements. Thus, the underlined leakage tests are of heater to cathode leakage only.

On cathode leakage test of light duty diodes in multi-section tubes, meter will not swing across the scale as for other type of tubes if tube under test is good, and there is no need to depress the H-K LEAK button. Underlining of pin #2 in case of 6AQ7 merely indicates cathode. The above also applies to other tubes of similar types such as 6R8, 6S8, and 6T8.

Standard for acceptance or rejection on Inter-Element Leakage (excluding cathode-heater leakage): No less than 5 megs on any test. A stricter standard for high re-



liability applications would be no less than 10 megs on any test.

Standard for Acceptance or Rejection on Cathode-heater Leakage: Not less than 1 meg for non-power types; not less than 500K for power types. Half these values may be acceptable for tubes approaching end of life, with the exception of tubes used in audio preamplifiers which may not read less than 1 meg at any time.

In general, tubes failing to meet these standards should be discarded. In any case, do not perform a MERIT test on any tube having an inter-element leakage resistance less than 100K ohms, as this may damage the tube tester. Note that all required inter-element and cathode-heater leakage tests for the entire tube have been completed with the tester set up for the first (or only) MERIT test and before the first (or only) MERIT test is made. No further leakage testing is performed thereafter.

**Note:** Depressing the buttons listed in the MERIT column actually tests that element for leakage until the MERIT lever is depressed. A tube giving too low an ohms reading in this condition should not be tested for MERIT.

16. Perform the first (or only) MERIT test on tubes which have been found satisfactory as to leakage and shorts by first pressing down the button listed in the MERIT column and then pulling down the MERIT lever switch. With the MERIT lever held down, read the merit (quality) indication on the DIODES GOOD scale for diodes and rectifiers, or the colored areas and percent markings for all other tubes. Note that although 100% represents normal conductance for a new tube, some tubes will read higher and some lower because of the tolerances allowed in tube manufacturing. Note also that the limits of the GOOD, ? (doubtful), and REPLACE areas are obtained by striking an average for all tube types and so should not be interpreted in an absolute manner.

17. If there is more than one line of settings for the tube, leave the tube in the socket and procede as follows for each line: a) Reset the lever switches and GRID and PLATE controls accordingly; b) Depress the button listed in the MERIT column; c) Pull down the MERIT lever switch to read the quality on the meter of the particular tube section under test.

18. After testing the last section of a tube, remove the tube from the socket of the tube tester. Push reset button and return all lever switches to "1". Failure to do this can result in damage to the meter when you proceed to test the next tube.

19. Proceed with testing another tube by beginning with Step 5. If there are no more tubes or transistors to be tested, turn the LINE ADJ. control counter-clockwise to its AC-OFF position. A slide switch at the end of the potentiometer winding opens the primary circuit of the power transformer and turns the tester off. If there is a transistor to be tested, procede directly to step 5 of TRANSISTOR TESTING after completing step 18 of TUBE TESTING.

CONTINUED PROCEDURE FOR TRANSISTOR TESTING

5. Locate the type number of the transistor to be tested on the transistor chart. Note whether the transistor is a n-p-n or a p-n-p type and the specified allowable range of Beta. Make sure that the TRANSISTOR TEST selector is set at "TUBE".

6. Insert the emitter (E), base (B), and collector (C) lead of the transistor in the corresponding terminals of the transistor socket located immediately above the TRANSISTOR TEST selector.

7. Turn the TRANSISTOR TEST selector from "TUBE" to position 1 on the p-n-p or n-p-n side depending on the type of transistor under test. The indication on the meter will be proportional to the collector current with emitter grounded and no base signal. On this test, transistors in good condition should read in the "I<sub>CEO</sub> GOOD" area (between 0 and 40 on the 0 to 140 scale); reject transistors that read outside the "I<sub>CEO</sub> GOOD" area (higher than 40 on the 0 to 140 scale), unless note has been made on the chart that a higher reading is acceptable.

8. Turn the TRANSISTOR TEST selector to position 2 and read the current amplification factor or Beta (change in collector current caused by a change in base current) on the 0 to 140 Beta Scale. A good transistor will read within the allowable range of Beta as given on the chart for the particular transistor type. Transistors which do not give a reading within the specified allowable range of Beta may still be useable; see data sheet.

9. Turn the TRANSISTOR TEST selector back to "TUBE" and then remove the transistor from the transistor socket.

10. Proceed with testing another transistor by beginning with step 5. If there are no more transistors or tubes to be tested, turn the tester off by turning the LINE ADJ. control to its AC-OFF position. If there is a tube to be tested, procede directly to step 5 of TUBE TESTING after completing step 9 of TRANSISTOR TESTING.

**NOTE:** The only controls having any affect in transistor testing are the TRANSISTOR TEST selector, the LINE ADJ. control, and the LINE push-button. Provided that a tube has not been left inserted in any of the tube sockets, the settings of any other lever switches, push-buttons or potentiometers on the panel have no effect and are immaterial.

## CIRCUIT DESCRIPTION

It may be of assistance in understanding the functioning of the instrument to examine the following typical partial schematics, each of which indicates the voltages applied and the placement of the meter circuit when performing the tests provided (in accordance with the detailed operating instructions) for tubes and transistors.

Note: R<sub>s</sub> denotes the meter shunt resistance selected by S23 (Lever S).  $\Phi$  1,  $\Phi$  2, and  $\Phi$  3 denote various a-c voltages taken from taps on the high voltage secondary winding of the power transformer and selected by S22 (Lever V). An asterisk denotes the function of current-limiting.



The functioning of the Model 666 in each of the various tests furnished is as follows:

**INTER-ELEMENT LEAKAGE:** A filtered dc test voltage of -70 volts is obtained by rectifying and filtering (CR1 and C1) the 50 volts ac obtained from filament winding tap. This voltage is applied between the tube element isolated by its transfer switch and the remaining tube elements whose lever switches are set at the plate, screen, and grid voltage busses which are grounded through the MERIT and H-K switches at their normal positions. The current through this circuit is read in ohms on the meter. Note that the polarity of the test voltage is evidently such as to eliminate cathode emission from the reading and that resistor R8 and LEAK CAL. rheostat R7 restrict the total current to 200 ua (full scale) even with a dead short. For heater-to-cathode leakage testing, the connection of the "remaining" elements to ground is broken by depressing the H-K push-switch to remove them from the circuit and leave in the test circuit the cathode and heater only. This is necessary because the cathode is placed at a negative voltage with respect to the "remaining" elements when it is selected by its transfer switch and the consequent cathode emission current would also register on the meter to give a false low reading of cathode-heater leakage.

**LINE ADJ:** For line adjustment, resistor R19 and LINE CAL rheostat R18 (identical to R8 and R7 respectively) are inserted in the leakage test circuit by depressing the LINE push-switch to exactly double the total resistance in the circuit and reduce the meter indication to exactly half scale. The condition for full-scale and half-scale reading, set in initial calibration with the LEAK CAL. and LINE CAL. rheostat R7 and R18, is that the LINE ADJUST potentiometer be set to give 130 volts across the full transformer primary (or 105 volts across the low end of the primary and the primary tap). The LINE ADJUST potentiometer permits duplication of this condition over a ±10% variation of the actual line voltage from the nominal value (117 volts).

**MERIT TEST:** Several of the many configurations that occur in MERIT testing are shown above. In general, each

test furnish a composite indication of cathode emission capability and the ability of each grid to control the plate current in accordance with the design of the tube, plus the ability of the plate to receive the regulated current. For diodes and rectifiers, the measurement is simply an emission test. To properly test a great variety of tube types, several plate, screen and ranges of grid voltage are available from taps on the plate secondary winding of the transformer for selection by switch S22 (lever V). These voltages are applied through switch 28 (MERIT) to the plate, screen, and grid bus bars inter-connecting corresponding terminals on switches S12 through 21 (lever switches 1 through 9 & C). The grid voltage is variable by R16 (GRID potentiometer) from zero to maximum of the range selected. Note that the plate, screen, and grid voltage contacts on switches S12 through 21 are grounded at the normal position of S28 and that plate, screen, and grid voltages are only applied when S28 is pulled down.

**TRANSISTOR TESTS:** At the P-N-P 1 or N-P-N 1 test positions of the TRANSISTOR TEST selector, a measurement is made of the collector current that flows when the emitter is grounded and no signal is applied to the base. This current is a function of the temperature, the resistivity of the germanium and, most important, becomes quite large if there is contamination of the surface of the germanium or if the transistor has been damaged by a short circuit. At the P-N-P 2 or N-P-N 2 positions, a small current is put into the base via the 200KΩ resistor R3 to permit measurement of the collector-to-base amplification factor Beta, sometimes call Alpha cb. In some cases the range of Beta given in the chart has been taken directly from the transistor manufacturer's specification; in other cases Beta has been calculated from the grounded-base Alpha, Alpha ce, according to the relationship:

$$\text{Beta} = \frac{\text{Alpha ce}}{1 - \text{Alpha ce}}$$

These simple tests will determine if the transistor is good or bad, but will not, of course, duplicate the factory tests of frequency response, input resistance, output resistance, collector capacitance and other electrical characteristics that are necessary for a specific grade of transistor.

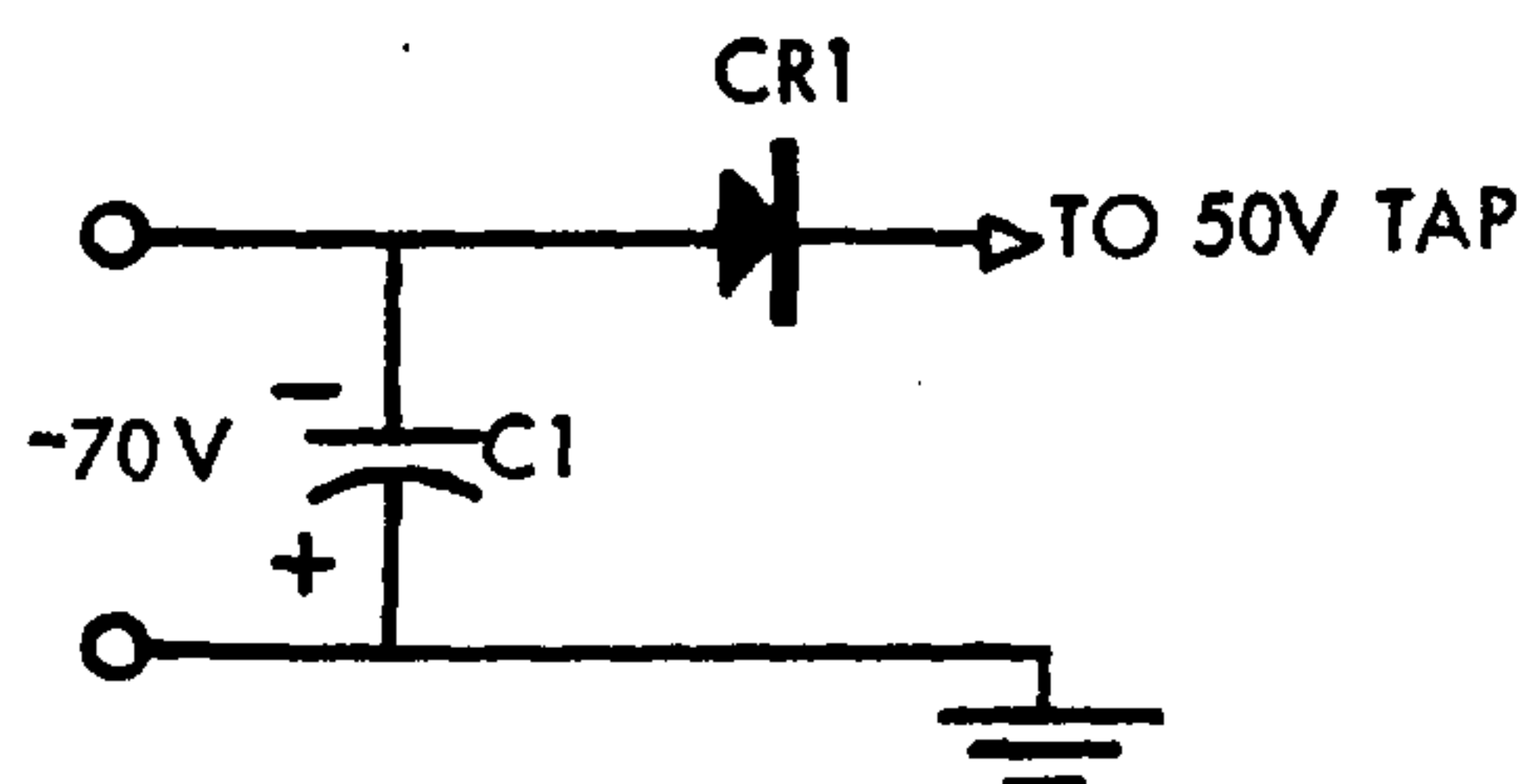

LEAKAGE TEST POWER SUPPLY — Also used for Line Adjust.

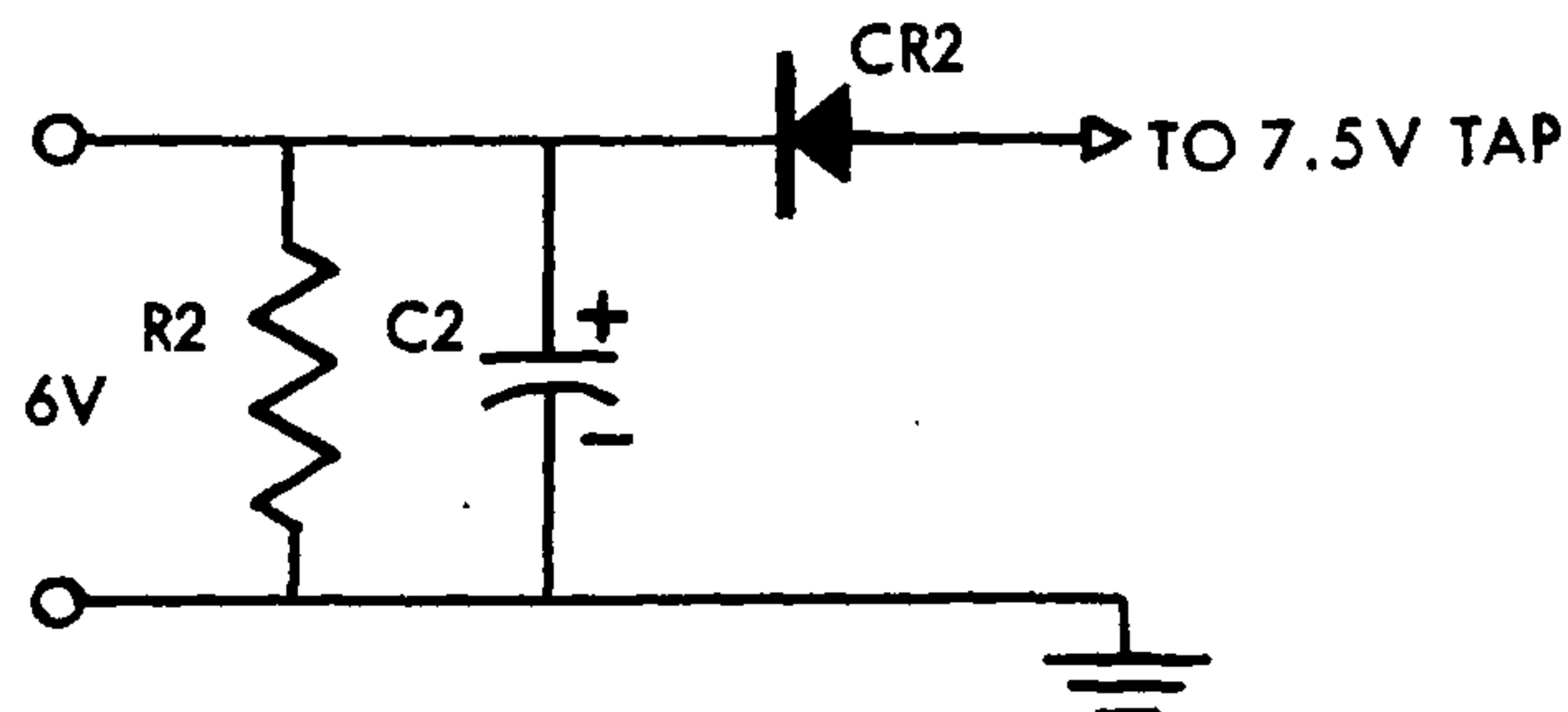

TRANSISTOR TEST POWER SUPPLY

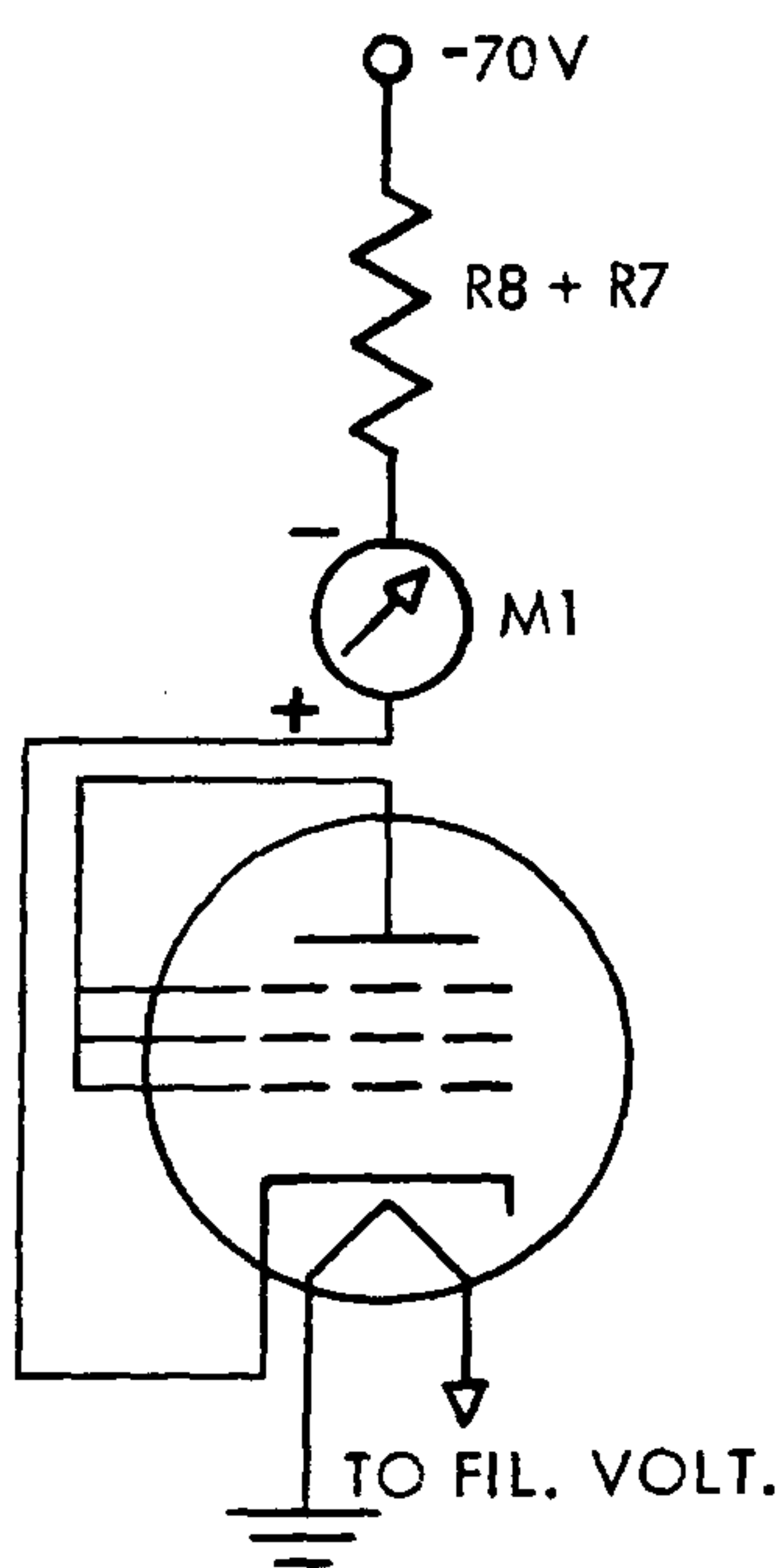

a) CATHODE-TO-HEATER LEAKAGE TEST

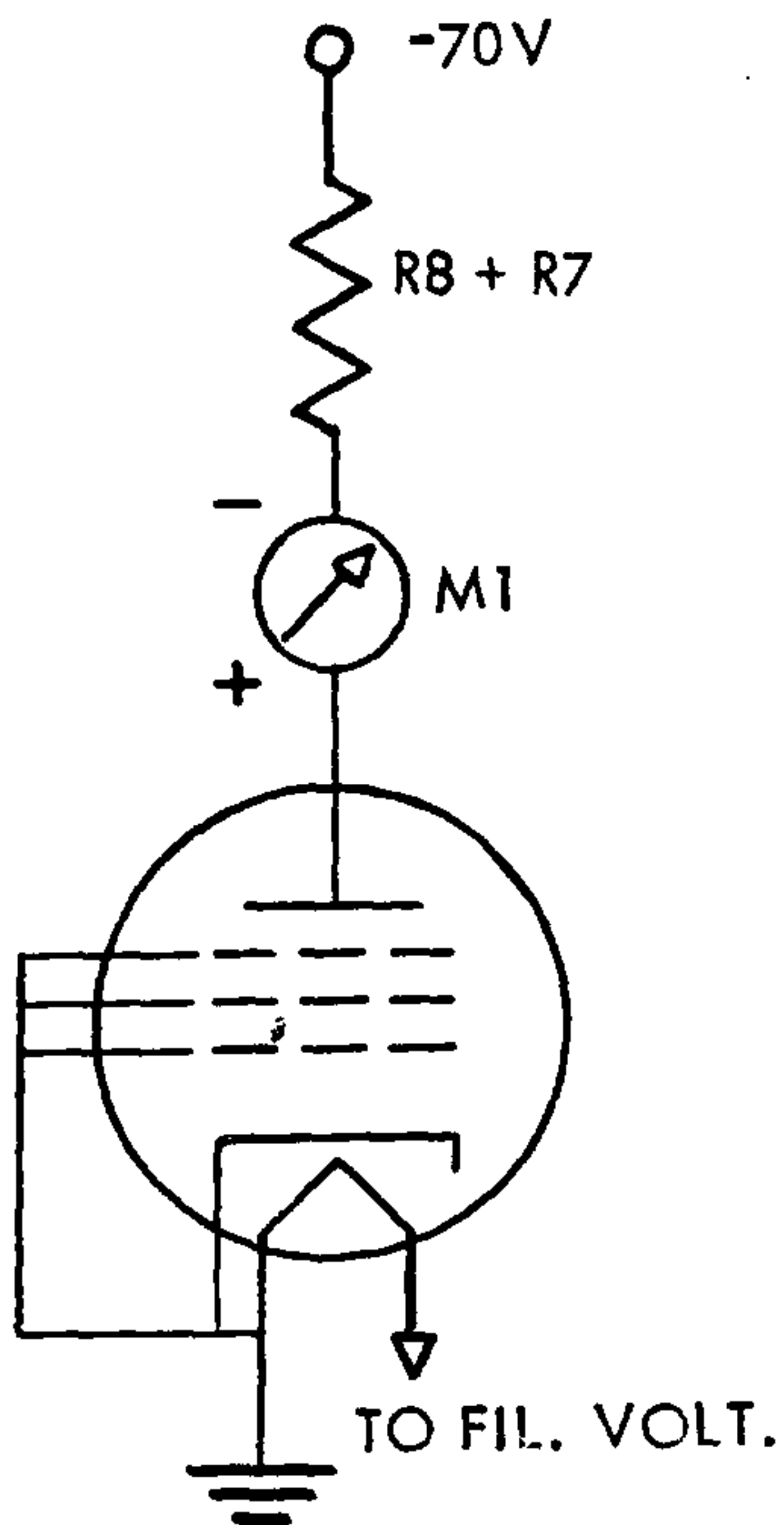

b) PLATE-TO-ALL LEAKAGE TEST

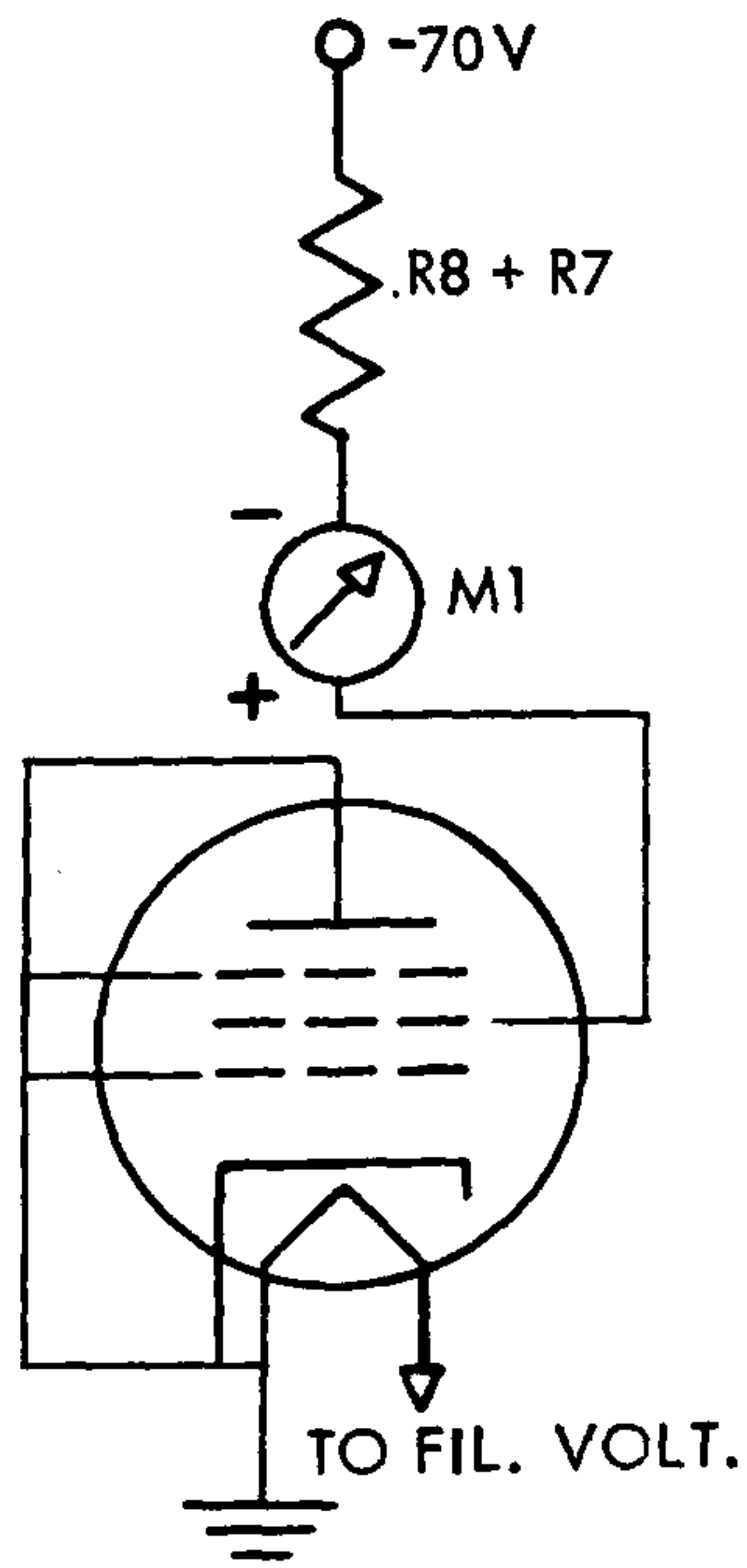

c) SCREEN-TO-ALL LEAKAGE TEST

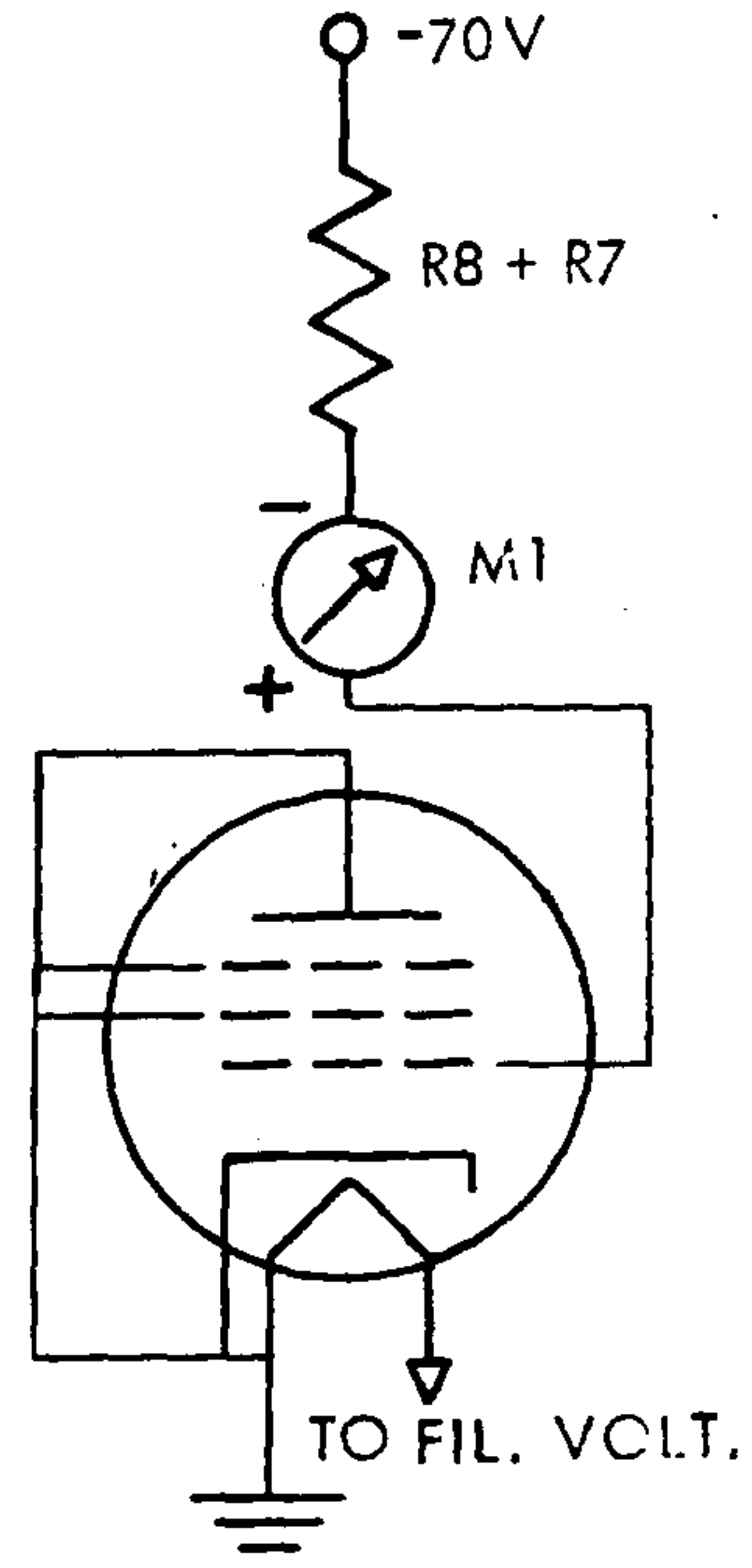

d) GRID-TO-ALL LEAKAGE TEST

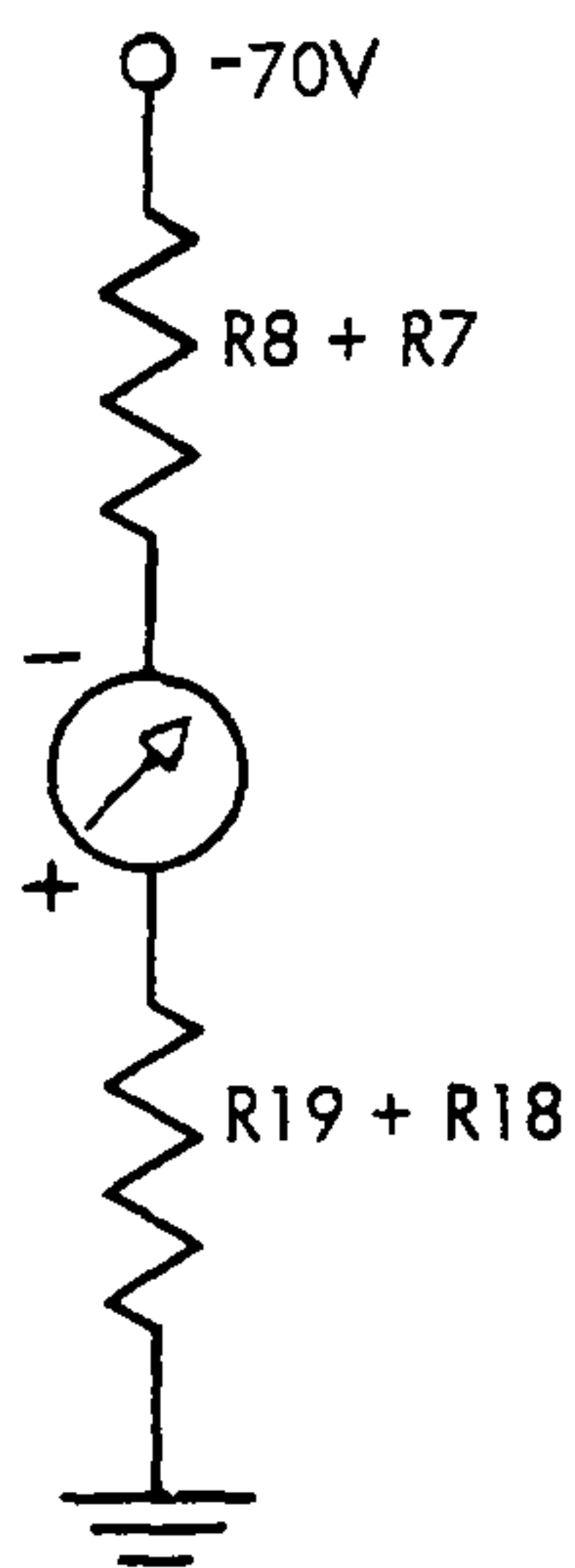

e) LINE ADJUST

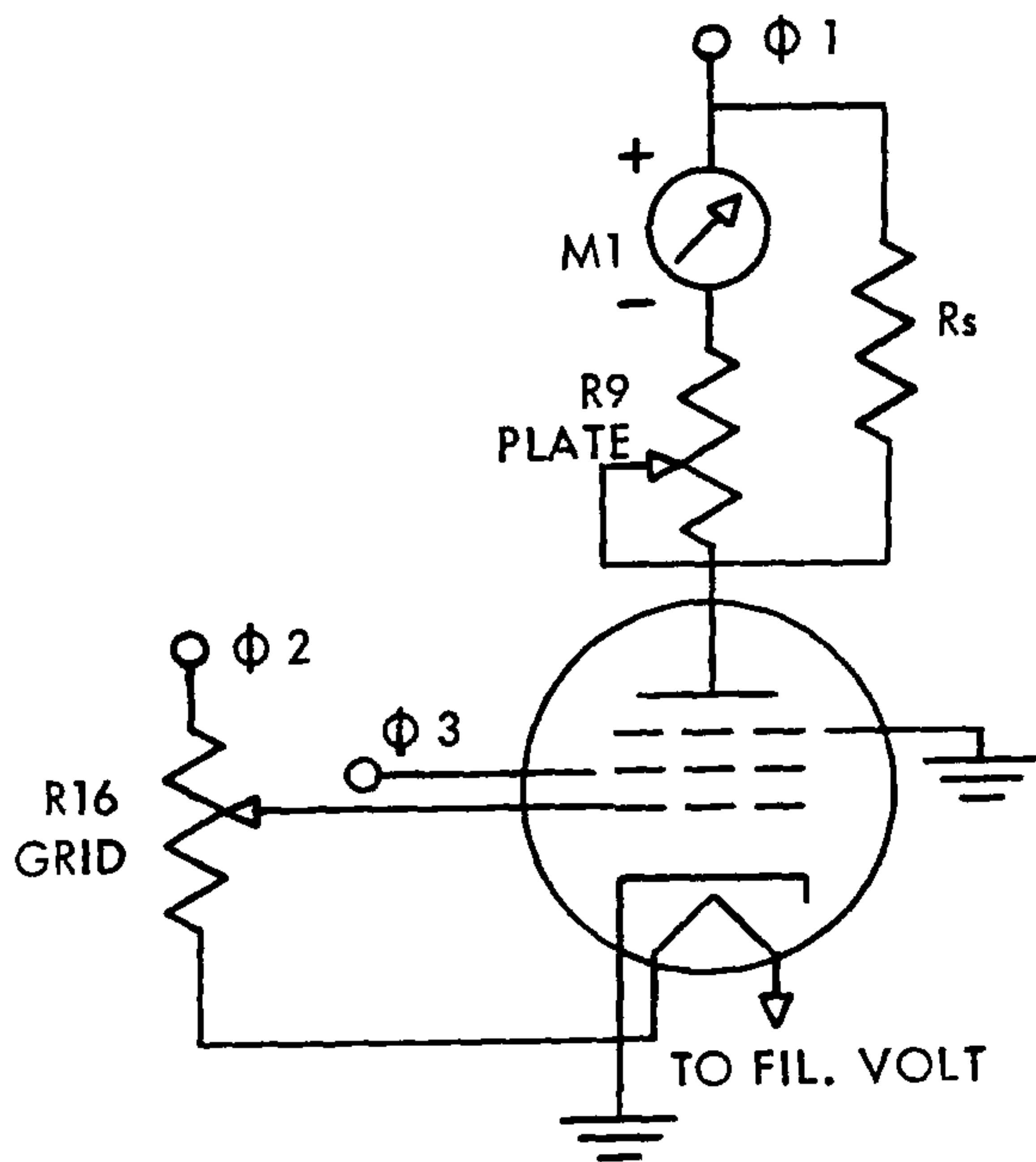

f) MERIT TEST of TYPICAL PENTODE

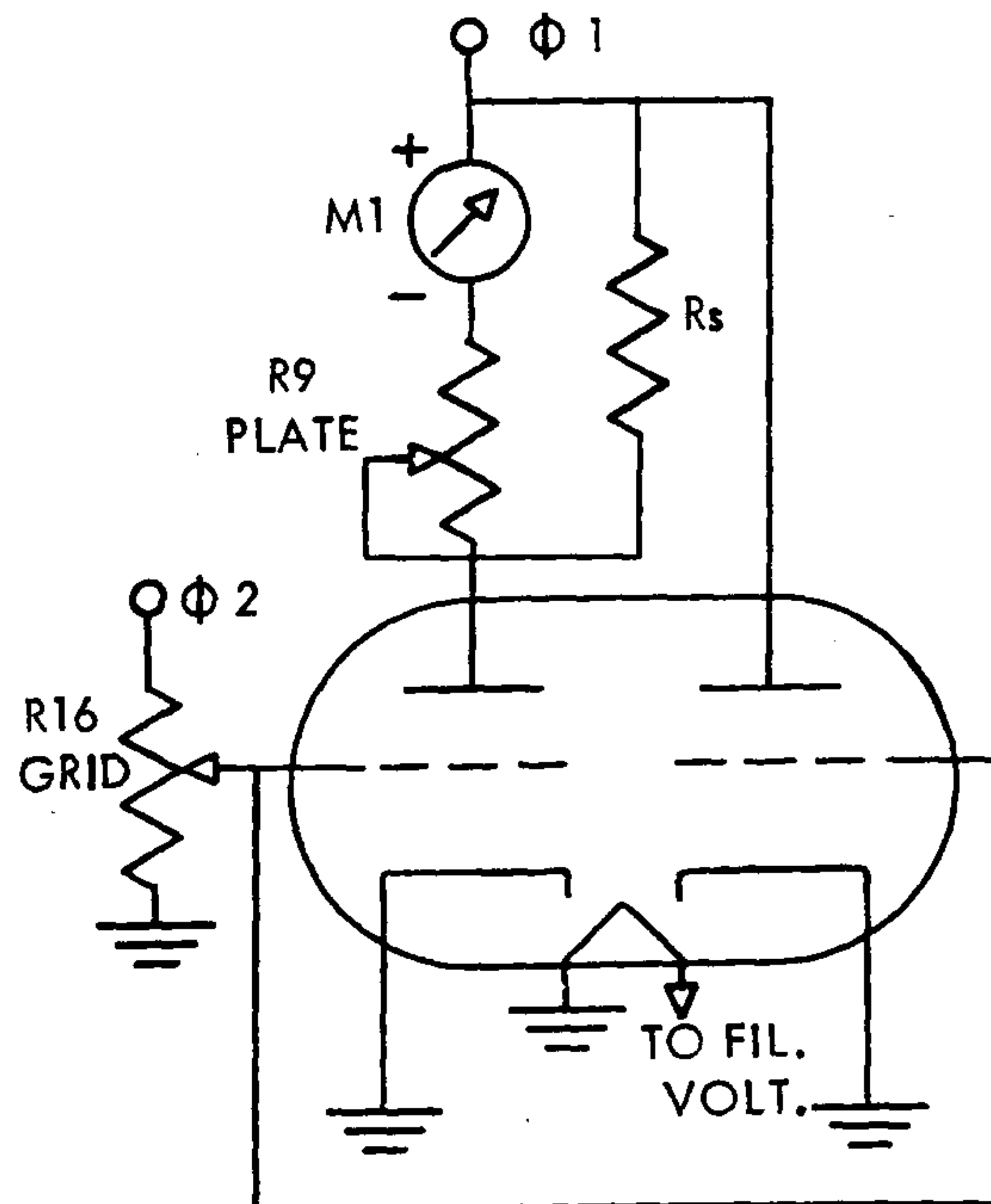

g) MERIT TEST OF TRIODE 1 of A DUO-TRIODE



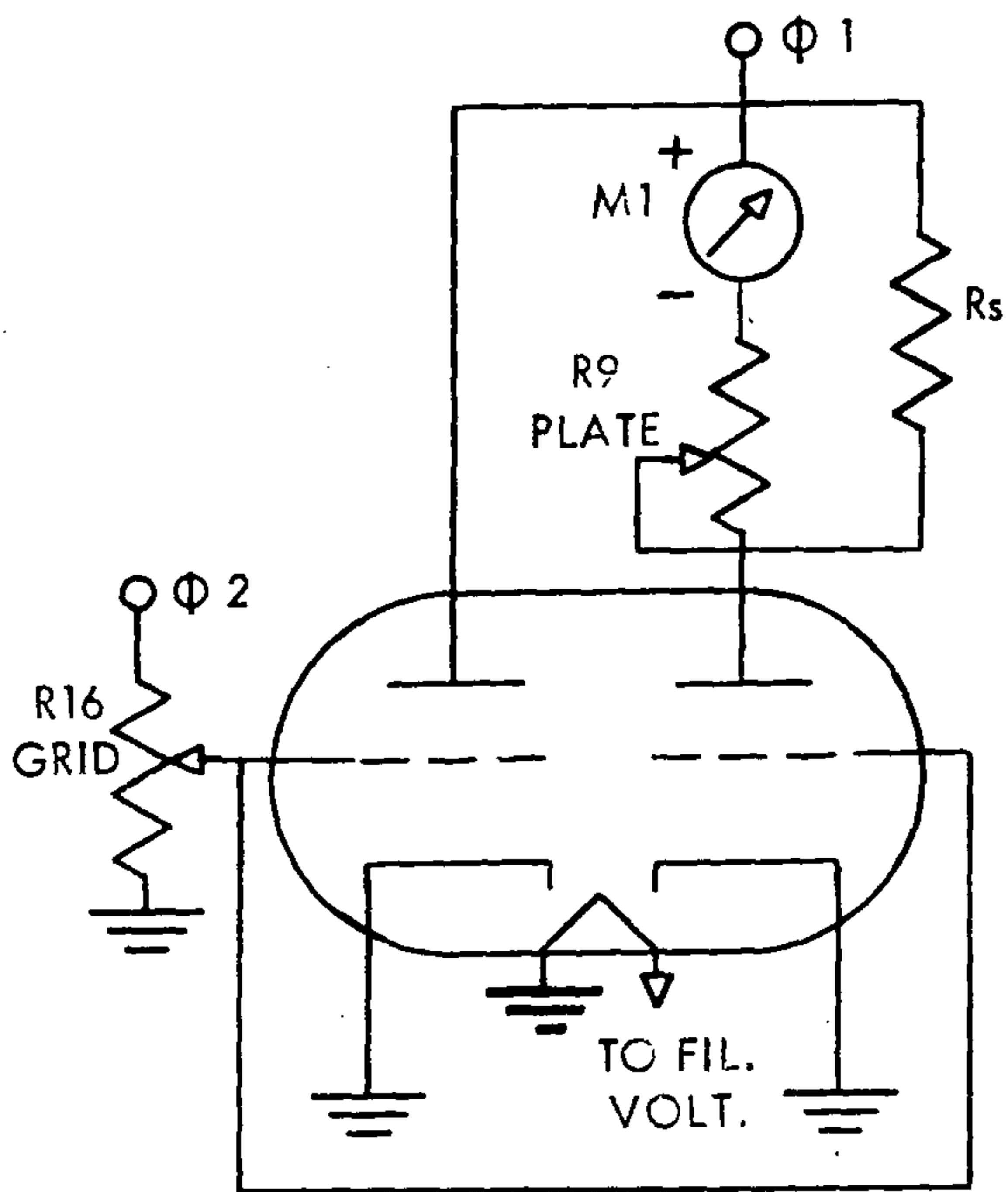

h) MERIT TEST OF TRIODE  
2 of a DUO-TRIODE

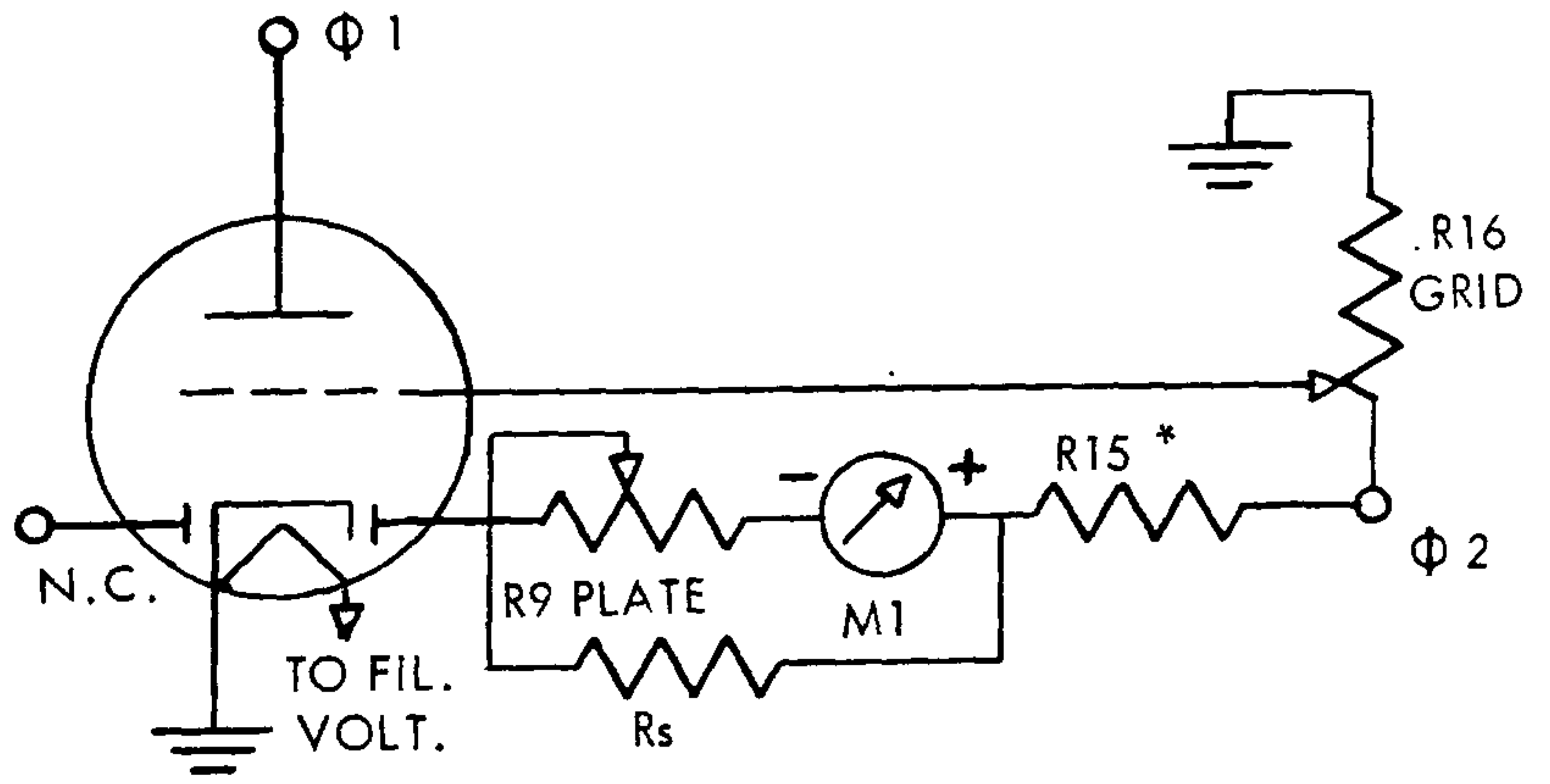

i) MERIT TEST of light-duty diodes, (showing one diode section of a triode duo-diode, such as a 12SQ7).

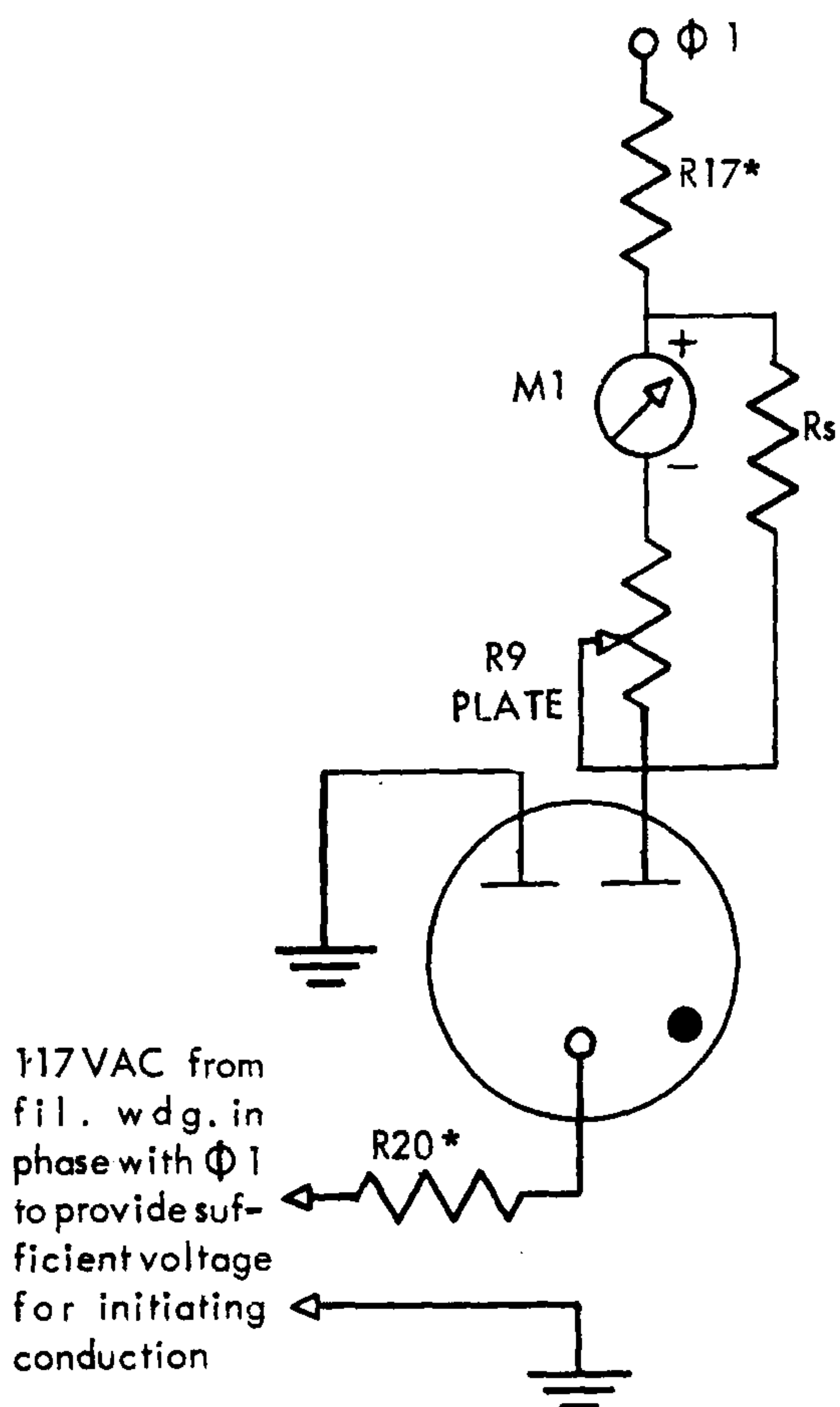

j) MERIT TESTING of OZ4, OY4 cold-cathode gas rectifiers (test of one section of OZ4 shown).

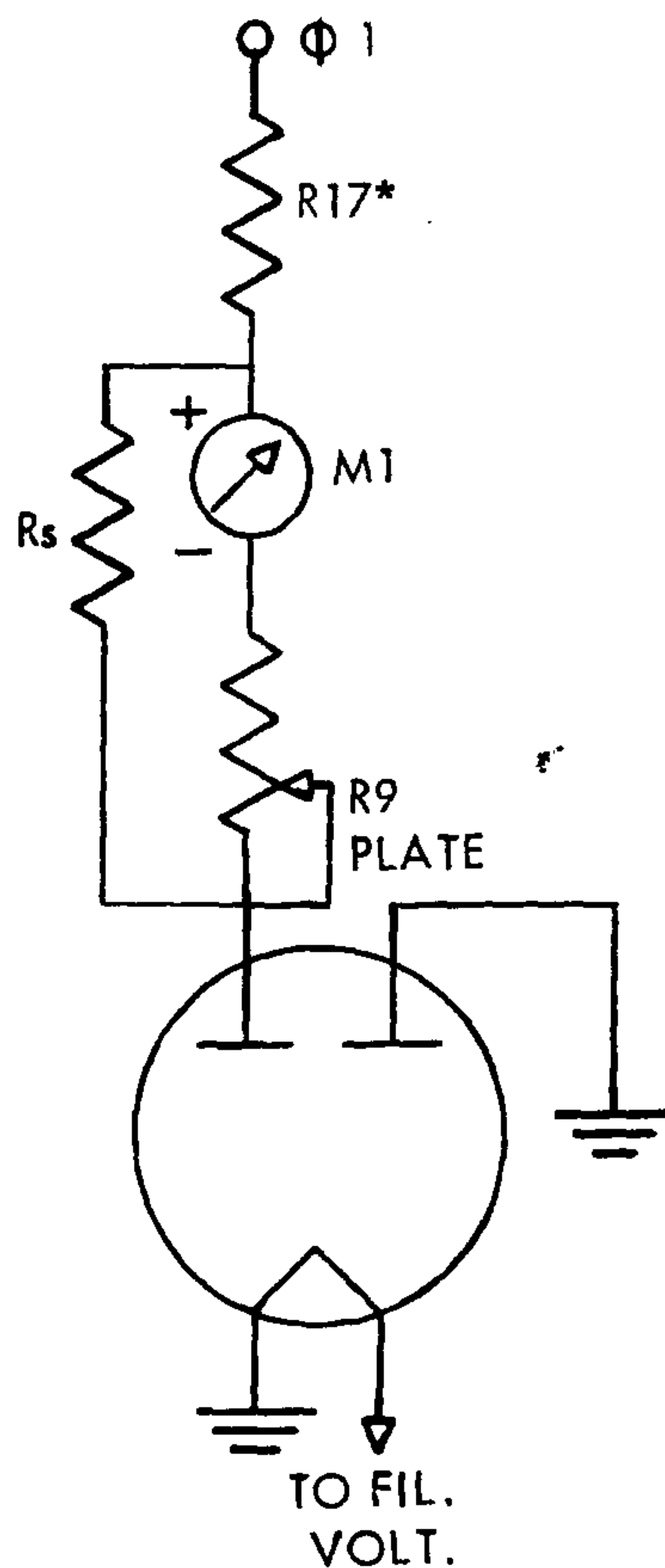

k) MERIT TEST for power rectifier section A of full-wave type.

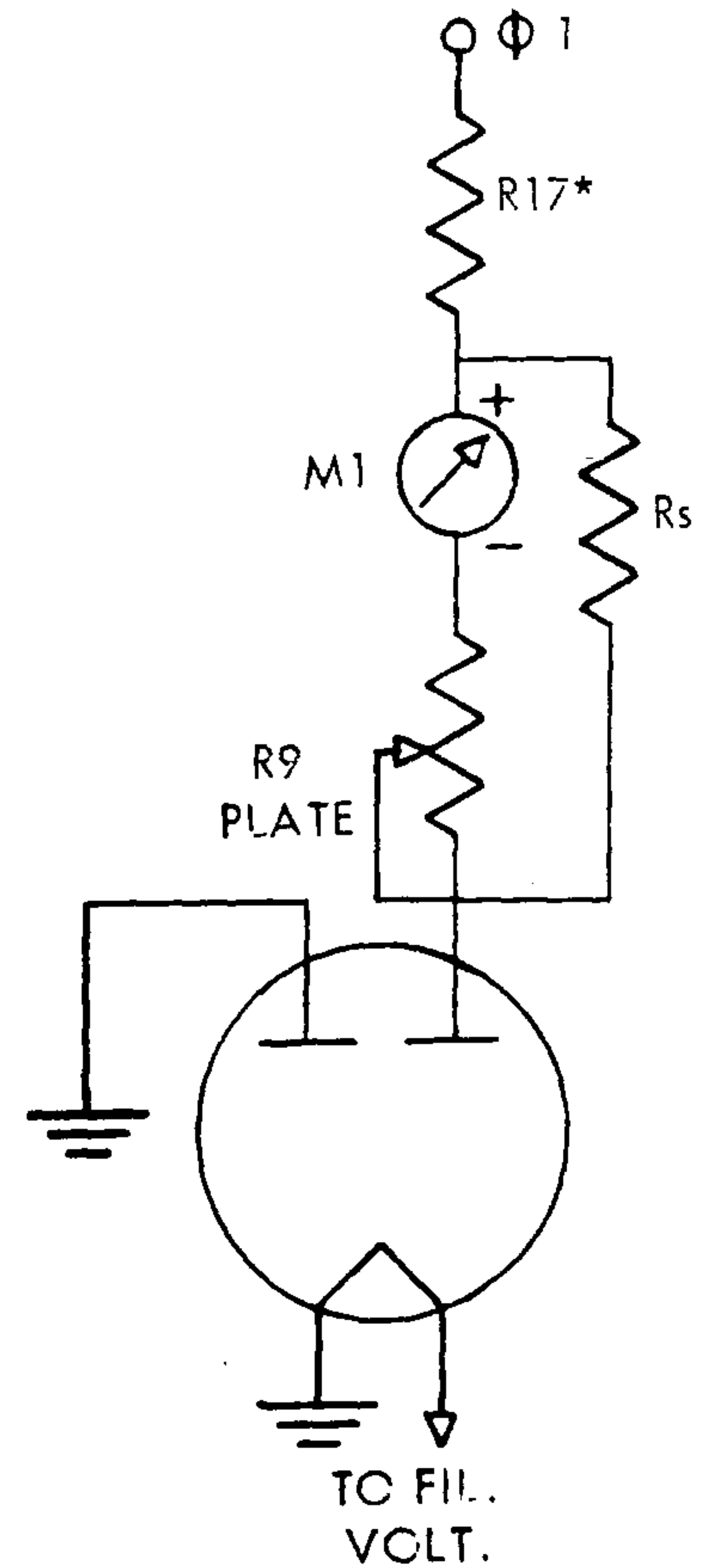

l) MERIT TEST for power rectifier section B of full-wave type.



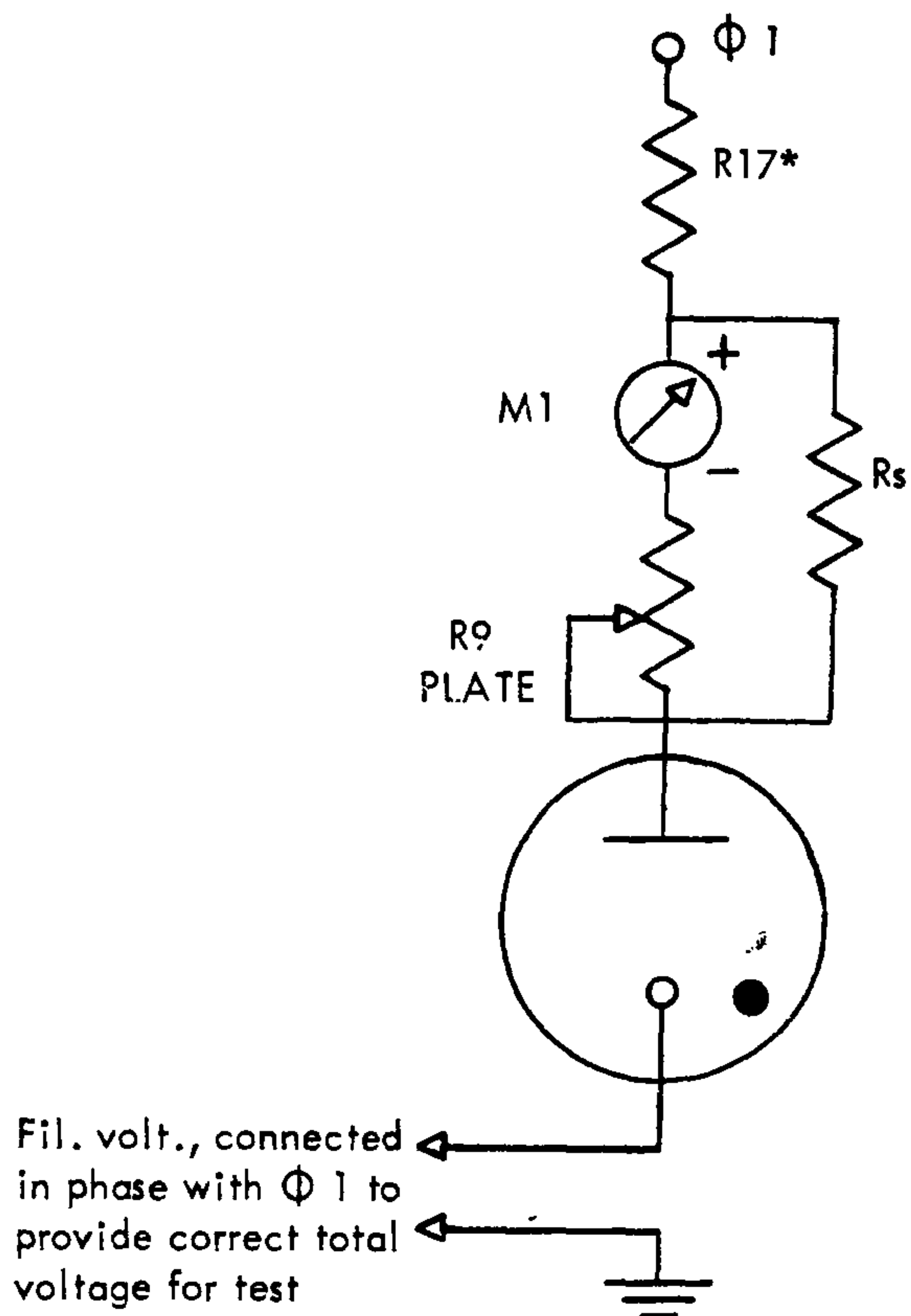

m) MERIT TESTING of OB2, OB3, OC3, & OD3 VR tubes.

## MAINTENANCE

**GENERAL:** Included in this section are instructions for internal adjustments, trouble-shooting, and part replacement. All internal adjustments must be performed in the order given on completed kit instruments before they can be placed in use. The same procedures will serve for periodic readjustments in both kit and factory-wired instruments when required by component aging or replacement.

**REMOVAL FROM CABINET:** To remove the instrument from the cabinet, first disconnect it from the power line and remove the 14 screws around the edges of the panel which fasten it to the flanges of the cabinet. As all components are assembled to the panel, removal consists simply of lifting the panel out of the cabinet.

**WARNING:** The operator is exposed to voltages as high as 300 volts A-C when the instrument is being operated outside of its cabinet. Take caution to avoid personal contact with these voltages.

**INTERNAL ADJUSTMENTS:** a) Disassemble the panel from the cabinet and lift the instrument out. b) With the instrument in its normal operating position and no power applied, adjust the reading of the meter pointer to zero by turning the mechanical adjustment screw on the meter face. c) Connect an a-c voltmeter of any type across the 0-130 v. taps of the power transformer and insert the line plug into a 105-130 volts AC, 50/60 cps line outlet. With no tube or transistor inserted in the test socket, and

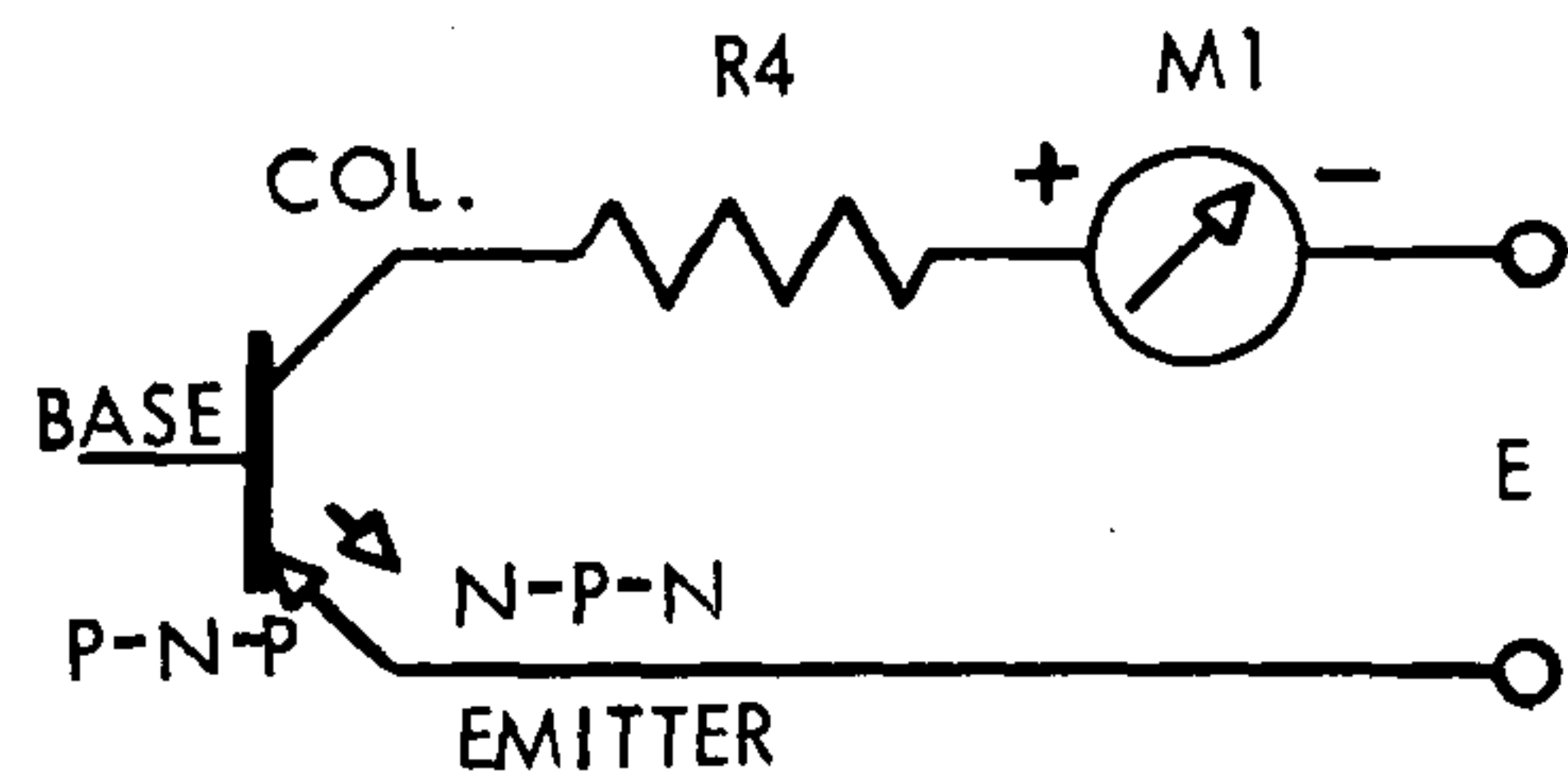

n) TRANSISTOR TEST 1 ( $I_{ceo}$ )

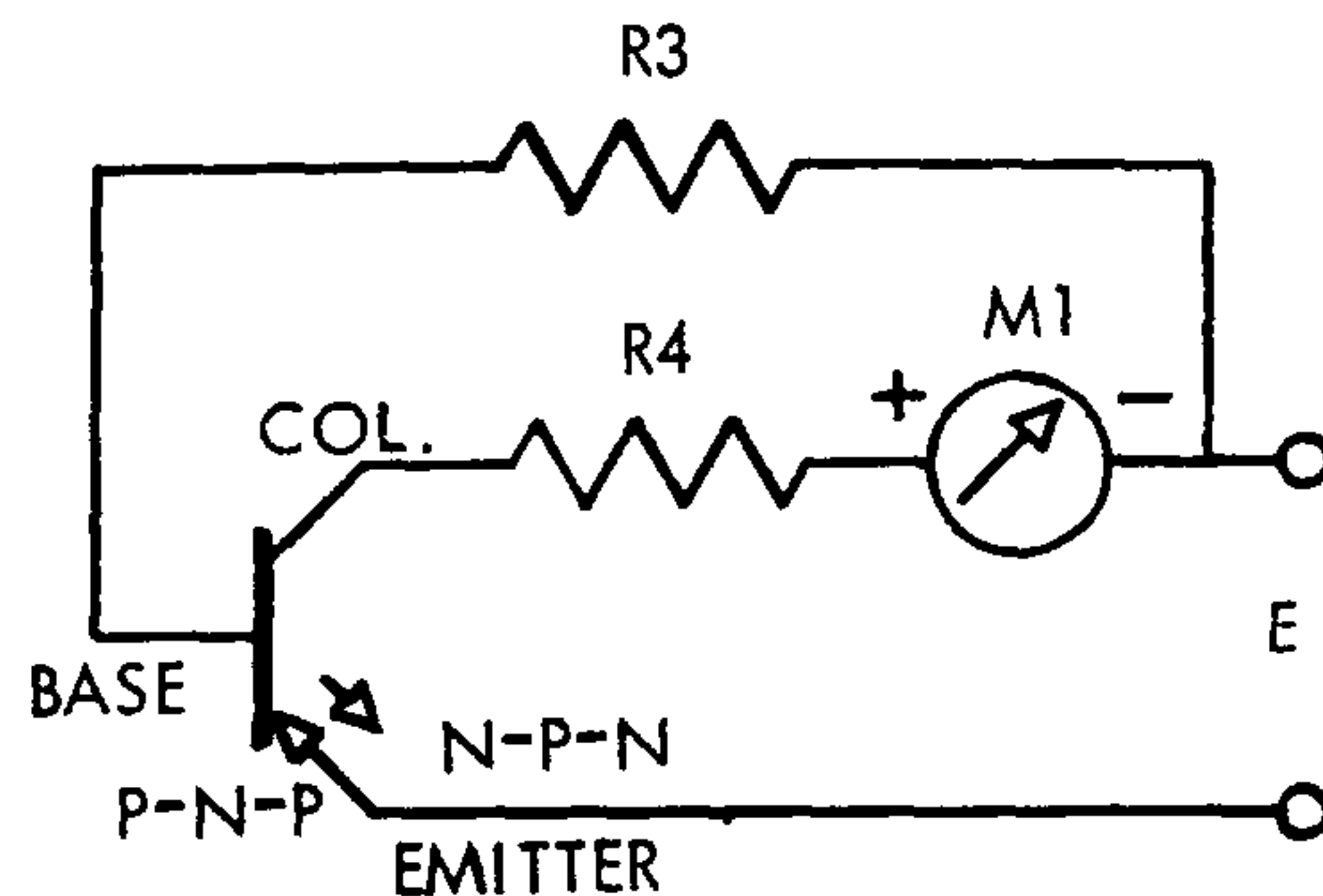

o) TRANSISTOR TEST 2 (Beta)

the TRANSISTOR TEST selector set at "TUBE", rotate the LINE ADJ. control R1 until the voltmeter reads 130 volts AC. d) Depress push-switch "C" so that it latches, and hold the metal clip on the cap lead against the panel so that it makes good electrical contact. Adjust the internal LEAK CAL. control, R7, for full-scale deflection on the meter (zero ohms on the leakage scale). e) Release the "C" push-switch by depressing the RESET push-button. Now depress the LINE push-switch and hold it down (this switch does not latch) while adjusting the LINE CAL. control, R18, for half-scale deflection (the short vertical "Line Adjust" on the meter scale). This completes the calibration of the instrument.

**Note:** The LEAK CAL. control, R7, is located on the underside of the chassis near the FILAMENT selector switch, the LINE CAL. control, R18, is also on the underside of the chassis, near the LINE ADJ. control.

**CLEANING TUBE & TRANSISTOR SOCKET TERMINALS:** After a long period of time, a film of dirt may form on the inside contact surfaces of the socket terminals which will prevent good contact with the inserted tube and transistor pins or leads. Spray or pour a little contact cleaner through the socket terminals, if this condition occurs, to remove the dirt film and restore good contact surfaces.

**Fuse Replacement:** A fuse in series with the primary winding of the power transformer protects the tube tester against damage due to overloading. Do not replace a blown fuse until you have located and corrected the cause of the failure, which can be any one of the following:

a) incorrectly set controls; b) voltage applied to shorted elements; c) a short developed within the circuit of the tube tester. In the last case, it will be necessary to use the schematic diagram to locate and remedy the source of trouble. Note that the fuse is a type 3AG 1 ampere and that it is mounted in a fuse clip on the side of the bracket supporting the power transformer. Do not use a higher ampere rating fuse type for replacement.

**ROLL CHART MECHANISM:** a) Springs: A small spring inside the roll chart mounting bracket provides a small tension against the bottom of one gear wheel to hold the roll chart in any position to which it is set. Excessive tension will impede fast rotation of the wheels when seeking tube information, and insufficient tension will result in a tendency of the roll chart to move from the set position. If necessary, reset the spring to provide the slight tension against the wheel required for satisfactory operation. b) Center shaft clips; There are speed-nut clips on either end of both center shafts that press against the outer wheel surfaces and hold the tube-and-wheels assemblies together. If these clips slip out on the shaft, the assemblies will become loose. Should this occur, it will be necessary to unscrew the bracket from the panel and remove the roller assemblies. Then press the clips against the outer wheel faces.

#### AVAILABILITY OF NEW TUBE & TRANSISTOR TEST DATA

#### ROLL CHARTS AND SUPPLEMENTS

As new tube and transistor types are released, an adequate number of samples of each type are carefully tested and rated in the EICO laboratories to establish the correct control settings for testing with the Model 666.

Periodically, new roll charts will be made available that include these new settings. With each new roll chart, a cumulative supplement of testing information on obsolete and rarely used types will also be supplied. When necessary, interim supplements of new testing information may also be made available.

By filling out and returning to EICO the registration card included with each instrument, the owner can be assured of notification when new charts and supplements are made available.

#### USING INTERIM SUPPLEMENT OF NEW TUBE INFORMATION

The new testing information contained in interim supplements, which may be available from time to time, can be easily entered on the roll chart in current use as follows: a) Rotate the wheel to the blank space left on the roll chart for this purpose; b) Lift the plastic window out of the panel. (It snaps out of place); c) Enter the new data on the roll according to the headings lettered on the panel; d) Carefully check to see that you have made the entries correctly; e) Push the plastic window back into the panel again. It will snap into place.

#### ROLL CHART REPLACEMENT

Any new roll chart will include new testing data from previous interim supplements plus any additional testing data obtained up to the time of publication; all new types will appear in their proper positions on the new roll chart.

To replace the roll chart, unfasten and lift out the panel assembly (the entire instrument) from the cabinet of the Model 666. Then remove the four screws which hold the roll chart bracket to the front panel. When the bracket is removed from the front panel, pull the ends to release both rollers and remove the rollers from the bracket. Unroll the chart from both rollers and pull off the tape which fastens the chart to each roller. Install the new chart as follows: a) Fasten the top end of the chart to one roller with good quality adhesive tape. The printed surface of the chart must face away from the roller; b) Wind the chart onto the roller carefully, being certain that it does not wrinkle or bind on the side wheels; d) Place the other roller under the one on which the chart is wound so that adjacent gears mesh—then pass the bottom end of the chart through the opening between the rollers and fasten it to the surface of the lower roller with another piece of adhesive tape (pull the chart tight onto the lower roller when you fasten the end to it); e) Insert the pair of rollers in the roll chart bracket with the full roll toward the open side, which when mounted is closest to the panel; f) Mount the bracket on the front panel again with the four screws which were removed at the beginning of the

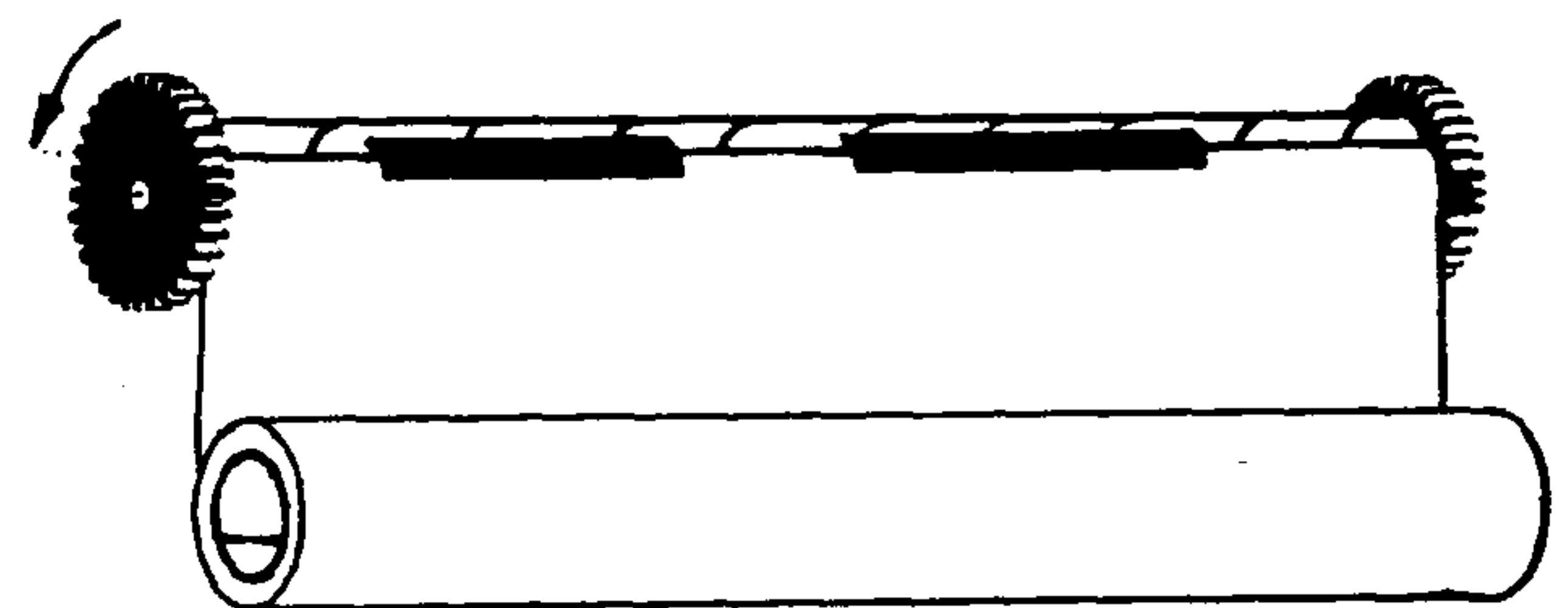

ATTACH TOP OF NEW CHART TO ONE ROLLER

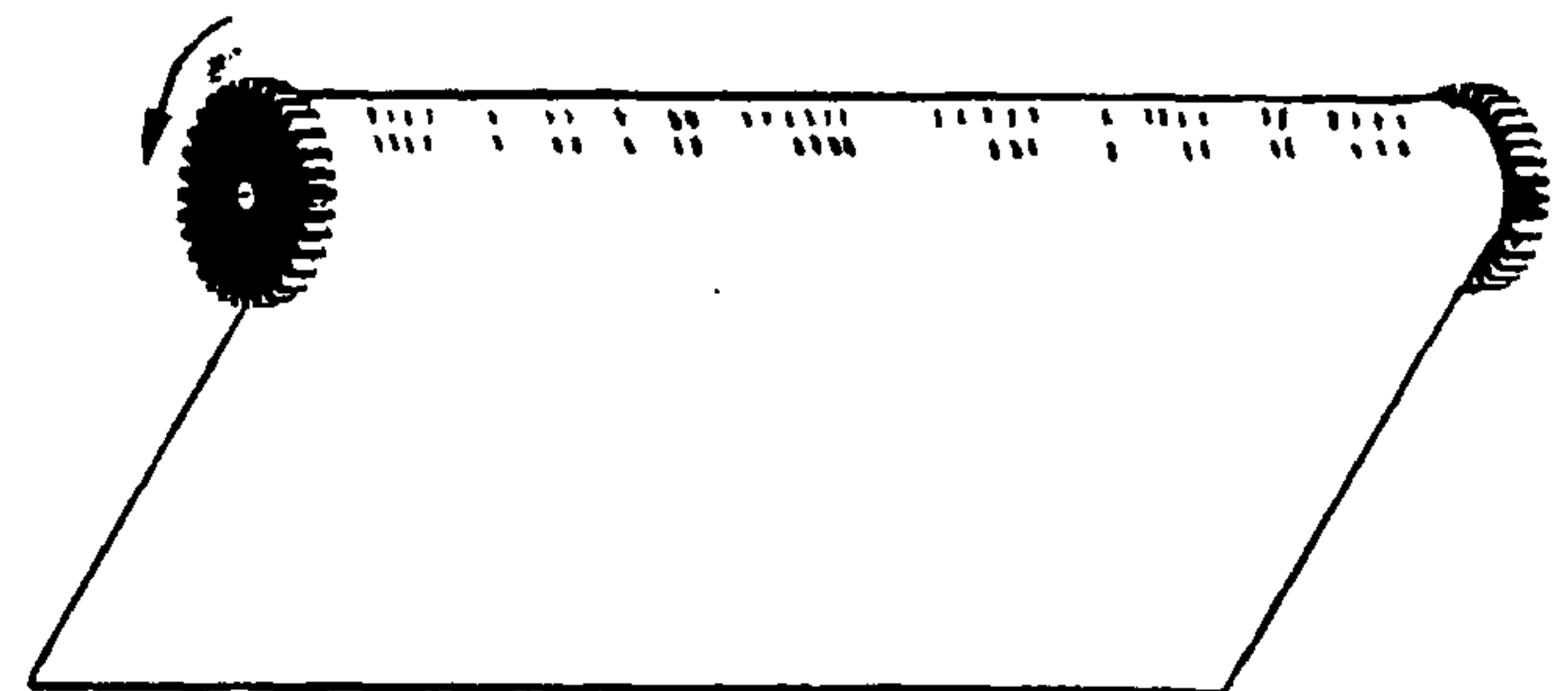

WIND NEW CHART ON ROLLER

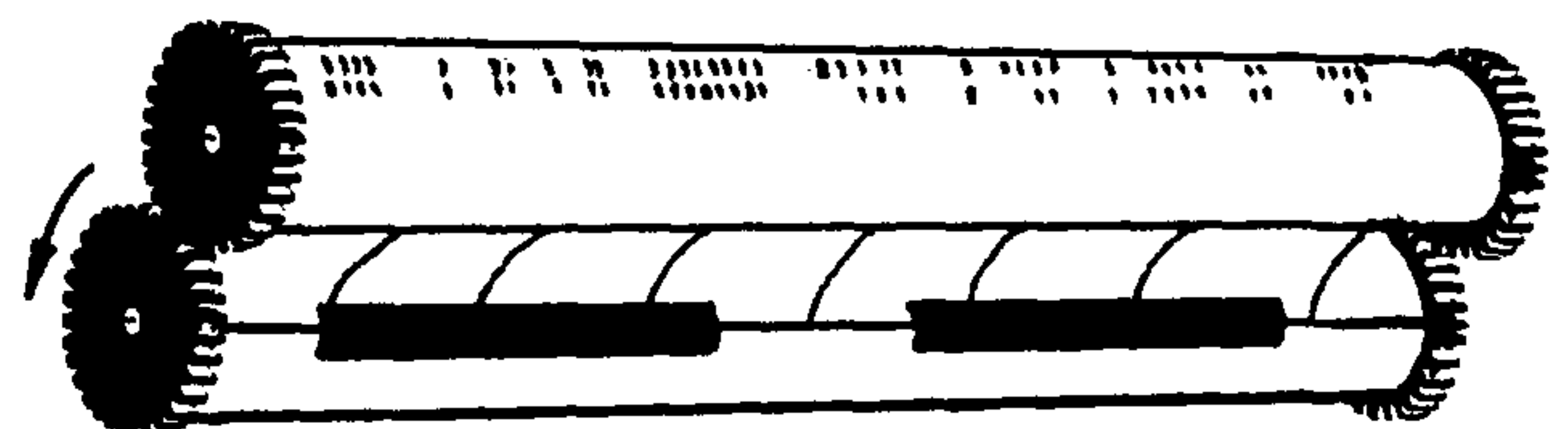

FASTEN BOTTOM OF NEW CHART TO SECOND ROLLER



replacement steps; g) Finally, check to see that the bracket has been mounted so that the printing on the chart reads right side up and that turning the wheels to roll the chart through its entire length does not reveal any binding on the wheels or the chart paper.

## SPECIAL APPLICATIONS

### CHECKING PILOT LAMPS AND CHRISTMAS TREE LAMPS

In the center of the large 7-pin socket is a receptacle for miniature-base lamps. It is suitable for either screw or bayonet base types, since both have center contacts on the end of the base and shells around the side of the base to serve as the other contact. As the wall around the receptacle is grounded and the center contact of the receptacle is connected to the rotor of the FILAMENT selector switch, whatever filament voltage is selected will be applied to a miniature-base lamp inserted in the receptacle for testing. The test procedure, therefore, is the following; a) Set the FILAMENT selector to the rated voltage of the lamp; b) Depress the LINE button and turn the LINE ADJ. potentiometer until the meter reads at the LINE ADJ. mark on the scale; c) Insert the lamp in the test receptacle. A good lamp will light to its normal intensity.

### DEVELOPING SETTINGS FOR NEW TUBES

Paragraphs a through k cover the procedure for all single triodes and pentodes. Paragraph l gives the procedure for half-wave rectifiers, and paragraph m the procedure for light-duty detecting diodes (usually in the same envelope with a triode or pentode). Paragraph n deals with testing dual-triodes, triode-pentodes, and full-wave rectifiers.

a) Set the TRANSISTOR TEST selector to "TUBE".

b) Set the FILAMENT selector switch to the required filament voltage. For center-tapped heaters, use the series connection with the higher filament voltage (see step c).

c) Set lever switches I through 9 and C to positions which will connect the proper source of voltage to each tube element. Levers I through 9 set the connections for base pins 1 through 9 respectively, and lever C sets the connection for the cap lead. The positions of the switches are as follows: 1 is ground; 2 is filament; 3 is screen or optional plate; 4 is plate; 5 is control grid; and 6 is open (no connection). The following rules must be observed: 1) One side of the filament must be grounded; filament taps must be connected to position 6; 2) For tubes having several pins connected to the same element, connect only one of these pins to the appropriate voltage (or ground, in the case of a cathode); all other such pins must be connected to position 6; 3) Connect all unused pins and internal shields to position 1 (ground) unless otherwise specified by the manufacturer; 4) All detecting diode plates (such as in the 6SQ7) must be connected to position 6; 5) For tubes having a maximum allowable DC plate vol-

tage less than 70 volts, position 3 must be used for the plate.

d) Insert the tube in the socket and allow it to heat up. Make the line adjustment in the usual manner. Then determine the push-buttons to be pressed in the leakage tests by consulting the base diagram of the tube and selecting the pin numbers which correspond to the elements. If the tube has an indirectly heated cathode, note which pin number is the cathode (for heater-cathode leakage testing). The pin numbers so determined correspond to the numbers of the push-button switches to press for the leakage tests. Enter the numbers of these push-buttons in the LEAK column of the roll chart, underlining the cathode button. It may be convenient to refer to a similar tube type in making these settings.

e) If the leakage tests described above show the tube satisfactory, proceed with the MERIT test procedure. If the leakage test results are unsatisfactory, do not proceed with further testing on the faulty tube, or the tube tester may be damaged.

f) Refer to the base diagram for the tube and determine the pin number for the plate. This push-button number should then be listed in the MERIT column and should correspond to the lever which you had set to position 4 (step c above). Press this button, remembering that this constitutes a plate-to-all leakage test until the MERIT lever is pulled down.

g) Refer to the published characteristics of the tube to find the maximum allowable plate current, or the highest typical operating current listed. Locate this plate current in one of the charts 1-5. Read the corresponding settings of the PLATE control and the chart number. Set lever S to the chart number, and the PLATE control to the value as read from the chart. Doing so establishes that the meter will read 100 on the scale when the plate current of the tube is equal to the desired value.

h) Consult the published tube characteristics again and find the maximum allowable dc plate voltage. Note that lever V applies 45 volts at position 1, 90 volts at position 2, and 180 volts at positions 3 and 4 (all in volts rms, 60 cps). The highest position of the V lever that may be used is the one at which the rms plate voltage applied does not exceed roughly two-thirds of the maximum rated dc plate voltage.

i) Set lever V at position 1 and the GRID control at 7. Hold down the MERIT lever and note the meter indication. Increase the GRID control until a meter indication of 100 is obtained. If this is not possible, release the MERIT lever, return the GRID control to 7, and advance the V lever to position 2. Again hold down the MERIT lever and adjust the GRID control for a meter indication of 100. Continue this procedure, setting lever V to positions 3 or 4, if necessary, to obtain the 100 meter indication. If the GRID control appears to "saturate", that is, if an increase in its setting causes very little increase in the meter indication, lever V should be advanced to the next position. Be careful not to exceed the maximum allow-



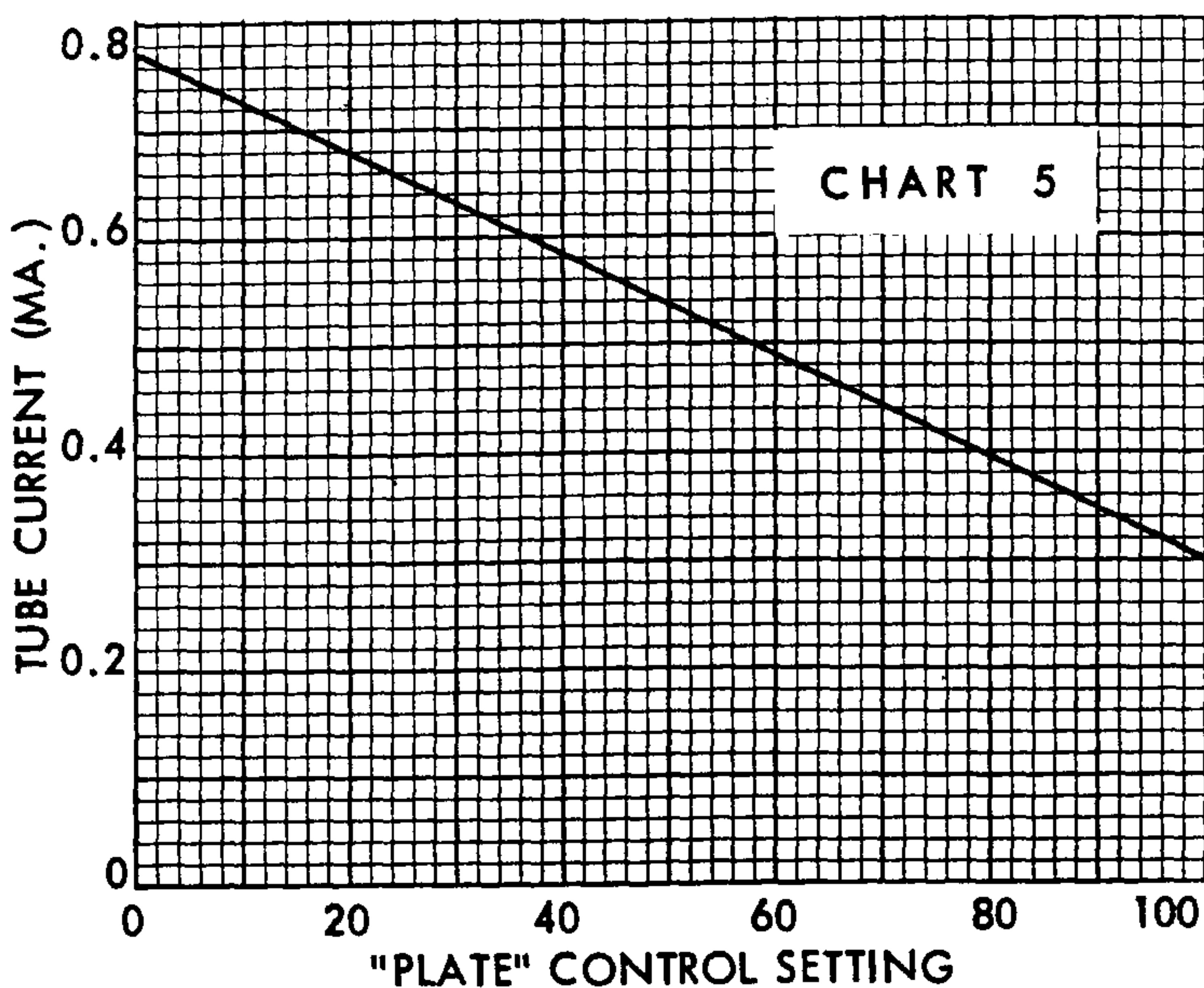
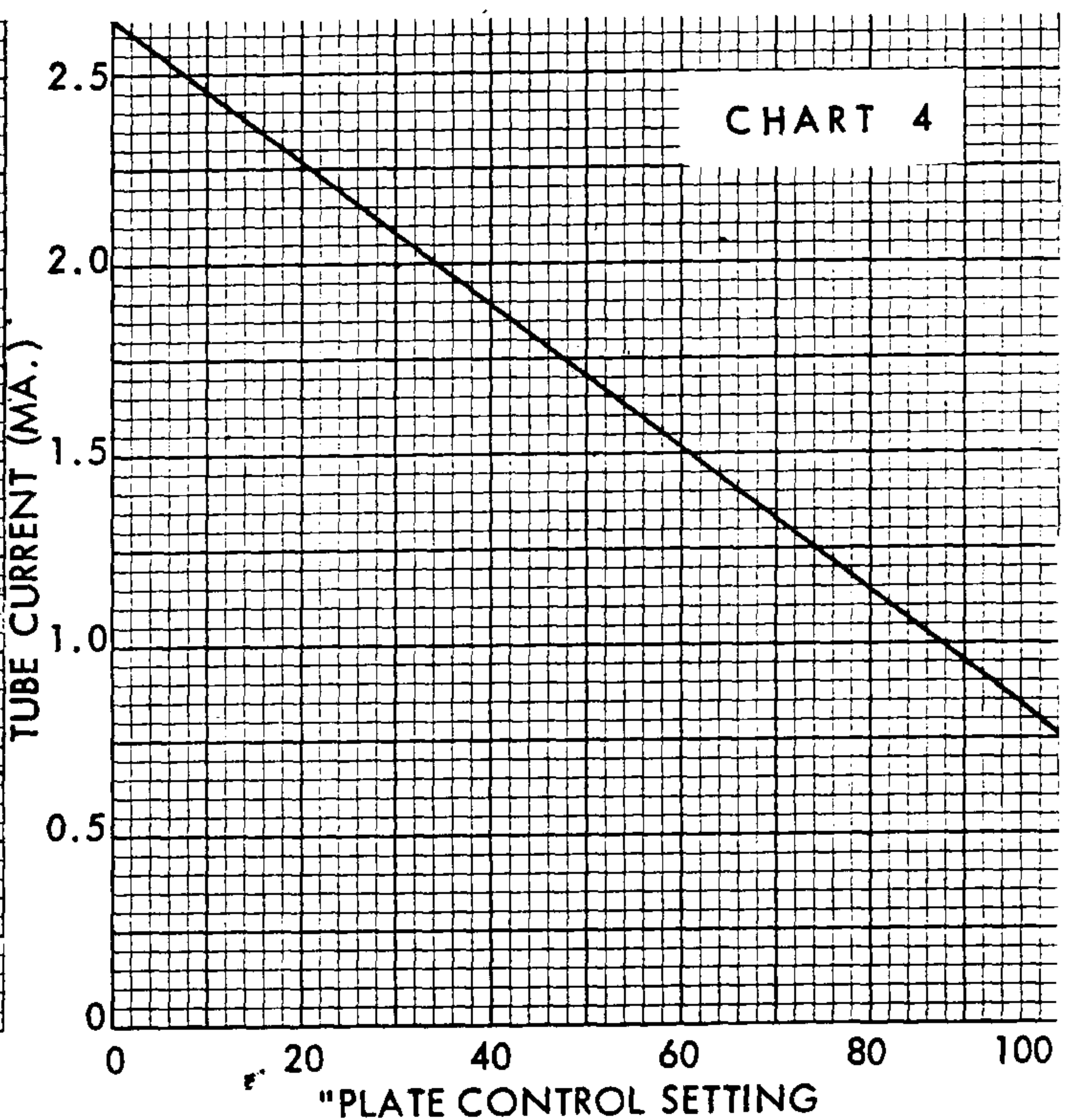
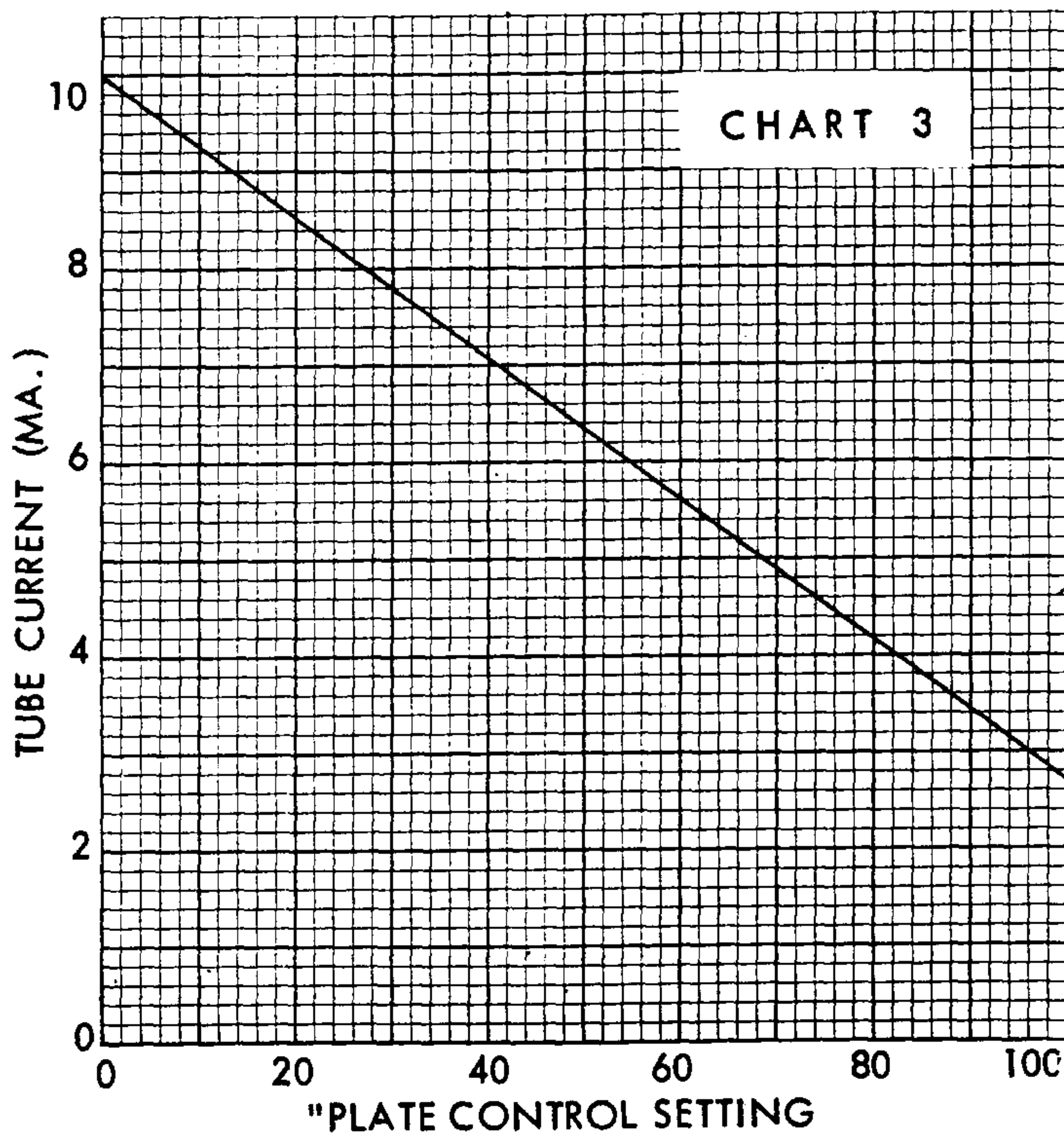
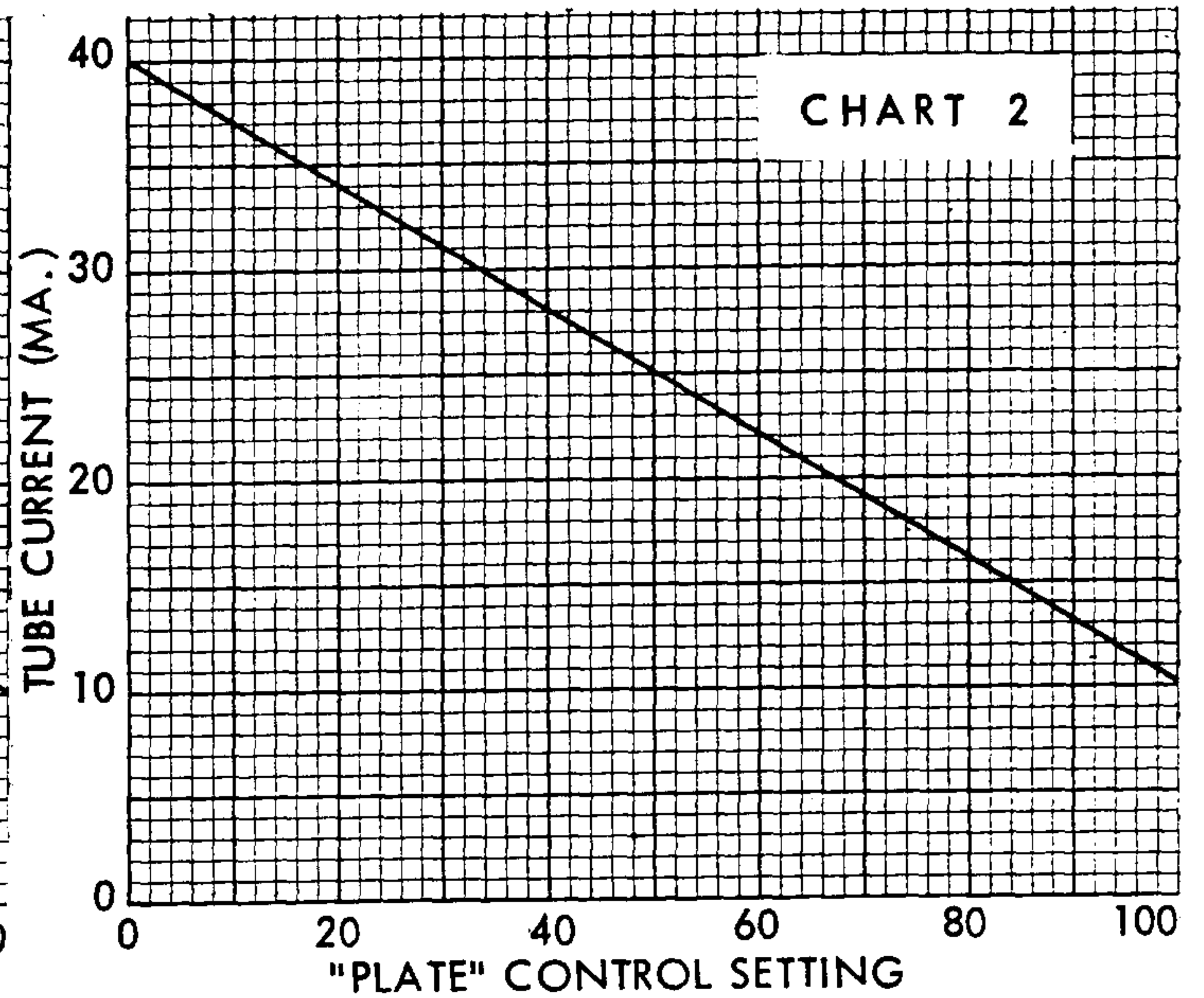
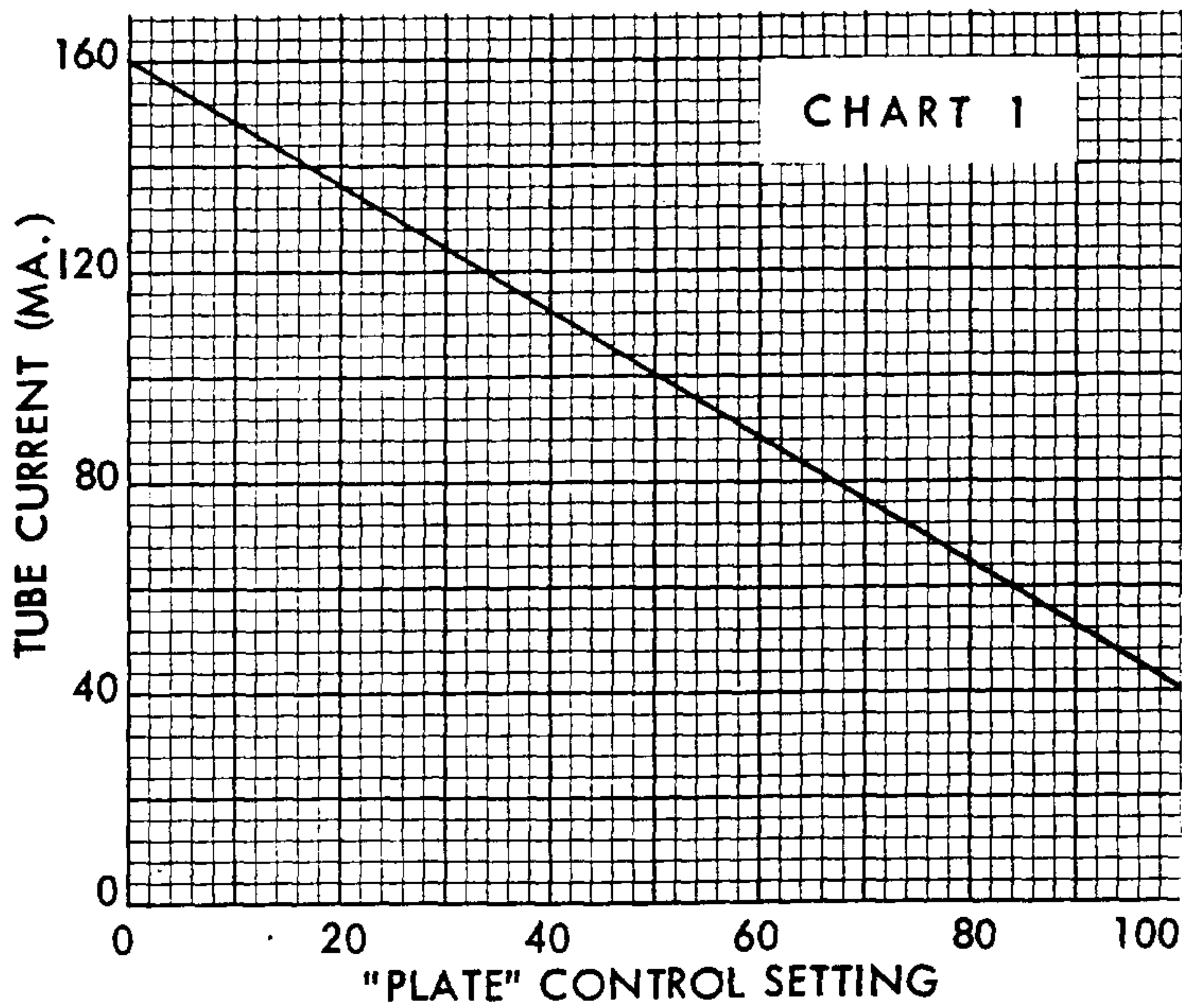

Notes: 1. These charts show the actual tube (plate or screen) currents drawn when the meter reads 100 on the 0-140 scale. For any other meter readings, multiply the indicated currents (from the appropriate chart) by the fraction  $X/100$ , where  $X$  is the actual meter indication.

2. Chart 1 is used when the "S" lever is set at position 1, chart 2 is for position 2, chart 3 is for position 3, chart 4 is for position 4, and chart 5 is used for positions 5 and 6.

3. These charts are to be used for "MERIT" testing of tubes only; they do not apply for line adjustment, leakage, or transistor tests.

4. Normally, only plate currents are measured. However, screen currents can be checked in the same manner by depressing the push-button corresponding to the pin number of the screen (substitute this number for the one shown in the MERIT column of the roll chart). Then pull back on the MERIT lever and read as above.



able plate voltage when making this setting. For the new 12 volt automobile radio types (30 volts dc maximum plate voltage), set the plate element lever to position 3 and the V lever to position 1 only. When the correct V lever and GRID control settings are found, release the MERIT lever and remove the tube from the tester.

j) Obtain the GRID control settings that give a reading of 100 on the meter for several other tubes of the identical type and establish an average setting.

k) Record the final settings of all controls under the proper column headings on the roll chart. The settings so obtained will permit you to test other tubes of this type until information is obtained from EICO on a new roll chart or supplement. Note that the settings you obtain may differ from the settings obtained using standardized or "bogie" tubes.

l) For a power rectifier, the procedure for obtaining MERIT test settings is the same up to step h) (The S lever and the PLATE control are set as usual to cause a meter reading of 100 on the 0-140 scale when maximum allowable plate current is drawn.) The GRID control is set at zero to actuate the switch which inserts the 400Ω current-limiting resistor. The V lever is set to position 1 and the MERIT lever held down while the meter is read. If the reading is substantially below 100, move the V lever to position 2, providing the voltage rating of the tube is not exceeded. If the reading is still substantially below 100 move the V lever to position 3, again providing that the voltage rating of the tube is not exceeded. If and when you come to a position of the V lever for which the meter reading does appreciably exceed 100, return the V lever to the next lower position and adjust the PLATE control for a meter reading of 100. If this does not occur even at V lever position 3 (the same plate voltage is applied at position 4), adjust the PLATE control for a meter reading of 100 at this position; the current drawn will normally be sufficient for a good test. Completion of the procedure is covered in steps j and k above, except that instead of finding an average GRID control setting (step j), find an average PLATE control setting.

m) For light-duty detecting diodes, such as are normally included in the same envelope with a triode or pentode, MERIT test settings should be obtained after developing the settings for the triode or pentode section. As instructed earlier, the diode plate levers are set to position 6 (which position they retain for the triode or pentode test. It will therefore normally not be necessary to reset levers 1 through 9 & C when going from the triode or pentode test to the diode(s) test(s). The S lever is always set at position 6 and the preliminary PLATE control setting determined by entering chart 5 at the maximum allowable diode plate current and reading off the corresponding PLATE control setting. The GRID control remains at the setting previously developed for the triode or pentode section (if any) in the same envelope. (Actually the GRID control setting has no effect in this test provided that it is set above 7; it is left at the previously developed setting to avoid unnecessary re-setting.) The V lever is set first at position 1 and the meter reading observed with

the MERIT lever held down. Note that the voltage applied to the diode in this test is the grid voltage selected by the V lever; namely 5 volts at position 1, 15 volts at positions 2 and 3, and 45 volts at position 4 (all in volts rms, 60 cps). Refer to these voltages to determine whether the maximum voltage that can be applied to the diode is exceeded at any V lever position. If the meter reading at the V lever position 1 is substantially less than 100 on the 0-140 scale, proceed to positions 2 and 4 successively (position 3 is identical to 2 as regards grid voltage) if needs be, observing the limitation of maximum allowable applied voltage. If and when you come to a position of the V lever for which the meter reading does appreciably exceed 100, return the V lever to the next lower position and adjust the PLATE control for a meter reading of 100. If this does not occur even at V lever position 4, adjust the PLATE control for a meter reading of 100 at this position; the current drawn will normally be sufficient for a good test. Completion of the procedure is covered in steps j and k above, except that instead of finding an average GRID control setting (step j), find an average PLATE control setting.

n) The foregoing applies only to single triodes, pentodes, light-duty diodes included in the same envelope with a triode or pentode, and half-wave rectifiers. For dual triodes or triode-pentodes, both sections of the tube should have the correct operating voltages applied simultaneously. For a triode-pentode, connect the triode plate lever to position 3, the pentode plate lever to position 4, and the pentode screen lever to position 3; both control grid levers may be set at position 5. Refer to the roll chart settings for the 6U8 and 12AU7 for this type of operation. In the case of full-wave rectifiers, only the section under test has the operating voltage applied. Refer to the roll chart settings for the 5U4 as a typical full-wave rectifier.

## SERVICE

If trouble develops in your instrument which you can not remedy yourself, write to our service department listing all possible indications that might be helpful. If desired, you may return the instrument to our factory where it will be placed in operating condition for \$8.50 plus the cost of parts replaced due to their being damaged in the course of construction. NOTE: Before returning this unit, be sure all parts are securely mounted. Attach a tag to the instrument, giving your home address and the trouble with the unit. Pack very carefully in a rugged container, using sufficient packing material (cotton, shredded newspaper, or excelsior), to make the unit completely immovable within the container. The original shipping carton is satisfactory, providing the original inserts are used or sufficient packing material is inserted to keep the instrument immovable. Ship by prepaid Railway Express, if possible, to Electronic Instrument Co., Inc., 33-00 Northern Blvd., Long Island City 1, N. Y. Return shipment will be made by express collect. Note that a carrier cannot be held liable for damages in transit if packing IN HIS OPINION, is insufficient.



### REPLACEMENT PARTS LIST

<u>Stk.#</u>	<u>Symbol</u>	<u>Description</u>	<u>Am't.</u>	<u>Stk.#</u>	<u>Symbol</u>	<u>Description</u>	<u>Am't.</u>
-23010	C1	cap., elec., 10mf-150V	1	-97030	XV9	socket, 8 pin, sub-minar	1
-23001	C2	cap., elec., 10mf-25V	1	-97029	XV10	socket, 7 pin, sub-minar	1
-93003	CR1	rectifier, 50ma	1	-40000		nut, hex, 6-32	14
-95000	CR2	rectifier, 1N48, diode	1	-40001		nut, hex, 3/8-32	5
-91002	F1	fuse, 1 amp	1	-40007		nut, hex, 4-40	4
-72006	M1	meter, 200ua, 1KΩ	1	-40017		nut tin. 8-32	8
-19012	R1	pot., WW, 200Ω, 25W, w/SPST	1	-40019		nut, tin., 6-32	6
-10406	R2	res., 680Ω, 1/2W, 10%	1	-40021		nut, tin., push-on 9/64	4
-11026	R3	res., 200K, 1/2W, 1%	1	-40023		nut, tin., push-on (8 pin sub-minar)	1
-10432	R4	res., 1K, 1/2W, 10%	1	-40024		nut, tin., push-on (7 pin sub-minar)	1
-11062	R5	res., 129Ω, 1/2W, 1%	1	-41003		screw, 8-32 X 3/8 Bd. H.	8
-11061	R6	res., 50Ω, 1/2W, 1%	1	-41014		screw, 6-32 X 3/8 Bd. H.	12
-18023	R7	pot., 100K, (LEAKAGE CAL.)	1	-41016		screw, 4-40 X 1/4 Bd. H.	6
-10544	R8	res., 270K, 1/2W, 5%	1	-41035		screw #6 X 1/4 self tap, Bd. H.	15
-19010	R9	pot., 3K, 4W, 5%	1	-42000		washer, flat, 3/8	9
-11056	R10	res., 683W, 1/2W, 1%	1	-42001		washer, lock, 3/8	1
-11057	R11	res., 171Ω, 1/2W, 1%	1	-42002		washer, lock, #6	15
-11058	R12	res., 42.7Ω, 1/2W, 1%	1	-42007		washer, lock #4	6
-11059	R13	res., 10.7Ω, 1/2W, 1%	1	-42500		retainer ring, large	1
-11060	R14	res., 3.57Ω, 1/2W, 1%	1	-42501		retainer ring, standard	6
-10774	R15	res., 24K, 1W, 5%	1	-42502		retainer ring, miniature	1
-19011	R16	pot., 5K, 4W, 5% w/SPST	1	-42504		retainer ring, sub-miniature	1
-14504	R17	res., 400Ω, 5W, 10%	1	-46000		grommet, rubber, 3/8	1
-18023	R18	pot., 100K, (LINE CAL.)	1	-46001		grommet, rubber, 1/4	1
-10544	R19	res., 270K, 1/2W, 5%	1	-53011		knob, round bar, pointed	5
-14505	R20	res., 3K, 5W, 10%	1	-53012		knob, lever & push-black	24
-65002	SA1	switch assem., push button (S1-S11)	1	-53013		knob, lever & push red	2
-65001	SA2	switch assem., lever (S12-S23)	1	-57000		line cord	1
-60042	S24	switch, rotary 22 Pos. (FILAMENT)	1	-80045		panel	1
-60046	S25	switch, rotary, 5 Pos. (TRANSISTOR)	1	-81079		bracket, left	1
	S26	switch, (part of R1) (AC-OFF)	1	-81080		bracket, right	1
-64001	S27	switch, push button (LINE)	1	-81081		bracket, transformer	1
-63000	S28	switch, lever (MERIT)	1	-81083		bracket, roll chart	1
	S29	switch, (part of R16)	1	-87002		handle, plastic, folding	1
-30017	T1	power transformer	1	-88028		cabinet	1
-97802	XF1	fuseholder	1	-88029		cabinet cover	1
-97709	XI1	pilot lite assembly	1	-89556		roll chart	1
-97031	XT1	socket, transistor	1	-89565		roll chart drive gear	4
-97015	XV1	socket, 9 pin min.	1	-89566		roll chart roller	2
-97013	XV2	socket, octal	1	-89567		roll chart rod	2
-97014	XV3	socket, loctal	1	-89568		roll chart damper	1
-97010	XV4	socket, 6 pin	1	-89569		roll chart window	2
-97008	XV5	socket, 5 pin	1	-98501		grid cap, black insul.	1
-97007	XV6	socket, 4 pin	1			- manual of instructions	
-97011	XV7	socket, 7 pin w/lamp socket	1			- wire	
-97012	XV8	socket, 7 pin min.	1			- spaghetti	
-92006	11	pilot lamp, #47-R	1				

NOTE: When ordering replacement parts, please include all of the following information: 1) stock number and description given in parts list; 2) quantity; 3) model number of instrument; 4) serial number of instrument (on panel). This information will expedite the processing of your order and insure your receiving the correct replacement parts.



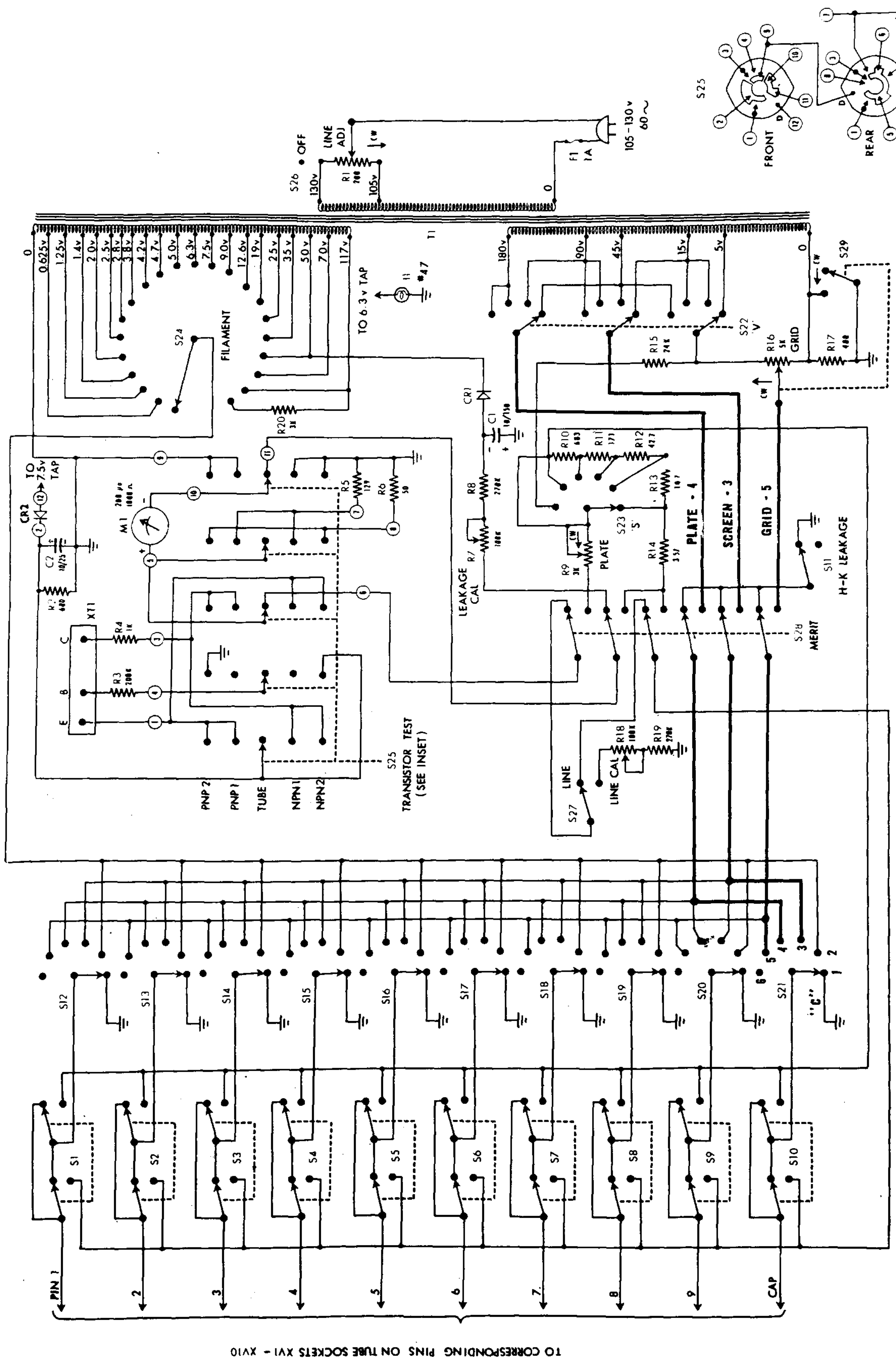

TO CORRESPONDING PINS ON TUBE SOCKETS XV1 - XV10

- NOTES:**
1. S1 to S11 are part of switch assembly SA1.
  2. S12 to S23 are part of switch assembly SA2.
  3. Resistances are in ohms unless otherwise specified (K = X 1000).
  4. Capacitances are in microfarads/working volts DC.
  5. CW indicates clockwise direction of rotation as seen from the front of the panel.



**MODEL 666 TUBE AND TRANSISTOR TESTER**

ELECTRONIC INSTRUMENT CO. INC.  
 3300 NORTHERN BLVD., L. I. CITY 1, N. Y.

# **K4XL's** **BAMA**

This manual is provided **FREE OF CHARGE** from the "BoatAnchor Manual Archive" as a service to the Boatanchor community.

It was uploaded by someone who wanted to help you repair and maintain your equipment.

If you paid anyone other than BAMA for this manual, you paid someone who is making a profit from the free labor of others without asking their permission.

You may pass on copies of this manual to anyone who needs it. But do it without charge.

Thousands of files are available without charge from BAMA. Visit us at <http://bama.sbc.edu>